



Simply Better Connections

PE4104A / PE4104AJ /  
PE4104G

IP Control Box  
User Manual

## Compliance Statements

---

### FEDERAL COMMUNICATIONS COMMISSION INTERFERENCE STATEMENT

This equipment has been tested and found to comply with the limits for a Class A digital device, pursuant to Part 15 of the FCC Rules. These limits are designed to provide reasonable protection against harmful interference when the equipment is operated in a commercial environment. This equipment generates, uses, and can radiate radio frequency energy and, if not installed and used in accordance with the instruction manual, may cause harmful interference to radio communications. Operation of this equipment in a residential area is likely to cause harmful interference in which case the user will be required to correct the interference at his own expense.

The device complies with Part 15 of the FCC Rules. Operation is subject to the following two conditions: (1) this device may not cause harmful interference, and (2) this device must accept any interference received, including interference that may cause undesired operation.

### FCC Caution

Any changes or modifications not expressly approved by the party responsible for compliance could void the user's authority to operate this equipment.

### Warning

Operation of this equipment in a residential environment could cause radio interference.

### Achtung

Der Gebrauch dieses Geräts in Wohnumgebung kann Funkstörungen verursachen.



### KCC Statement

유선 제품용 / A 급 기기 (업무용 방송 통신 기기)  
이 기기는 업무용 (A 급) 전자파적합기기로서 판매자 또는 사용자는 이  
점을 주의하시기 바라며, 가정 외의 지역에서 사용하는 것을 목적으로  
합니다.

**Industry Canada Statement**

This Class A digital apparatus complies with Canadian ICES-003.

**CAN ICES-003 (A) / NMB-003 (A)****VCCI Statement**

この装置は、クラスA機器です。この装置を住宅環境で使用すると電波妨害を引き起こすことがあります。この場合には使用者が適切な対策を講ずるよう要求されることがあります。

**VCCI - A****RoHS**

This product is RoHS compliant.

## **User Information**

---

### **Online Registration**

Be sure to register your product at our online support center:

---

International	<a href="http://eservice.aten.com">http://eservice.aten.com</a>
---------------	---

---

### **Telephone Support**

For telephone support, call this number:

---

International	886-2-8692-6959
China	86-400-810-0-810
Japan	81-3-5615-5811
Korea	82-2-467-6789
North America	1-888-999-ATEN ext 4988 1-949-428-1111

---

### **User Notice**

All information, documentation, and specifications contained in this manual are subject to change without prior notification by the manufacturer. The manufacturer makes no representations or warranties, either expressed or implied, with respect to the contents hereof and specifically disclaims any warranties as to merchantability or fitness for any particular purpose. Any of the manufacturer's software described in this manual is sold or licensed *as is*. Should the programs prove defective following their purchase, the buyer (and not the manufacturer, its distributor, or its dealer), assumes the entire cost of all necessary servicing, repair and any incidental or consequential damages resulting from any defect in the software.

The manufacturer of this system is not responsible for any radio and/or TV interference caused by unauthorized modifications to this device. It is the responsibility of the user to correct such interference.

The manufacturer is not responsible for any damage incurred in the operation of this system if the correct operational voltage setting was not selected prior to operation. **PLEASE VERIFY THAT THE VOLTAGE SETTING IS CORRECT BEFORE USE.**

## Product Information

---

For information about all ATEN products and how they can help you connect without limits, visit ATEN on the Web or contact an ATEN Authorized Reseller. Visit ATEN on the Web for a list of locations and telephone numbers:

International	<a href="http://www.aten.com">http://www.aten.com</a>
North America	<a href="http://www.aten-usa.com">http://www.aten-usa.com</a>

## Package Contents

---

Check to make sure that all the components are in working order. If you encounter any problem, please contact your dealer.

- ◆ 1 IP Control Box
- ◆ 1 standard rack mount kit
- ◆ 1 power cord (applicable to PE4104G only)
- ◆ 4 foot pads
- ◆ 10 cable ties (applicable to PE4104AJ only)
- ◆ 1 user instructions

# Contents

---

Compliance Statements . . . . .	ii
User Information . . . . .	iv
Online Registration . . . . .	iv
Telephone Support . . . . .	iv
User Notice . . . . .	iv
Product Information . . . . .	v
Package Contents . . . . .	v
Contents . . . . .	vi
About This Manual . . . . .	ix
Conventions . . . . .	x

## **Chapter 1. Introduction**

Overview . . . . .	1
Features . . . . .	2
Requirements . . . . .	4
Optional Accessories . . . . .	5
Sensors . . . . .	5
Sensor Management . . . . .	5
Cable Holders . . . . .	5
Components . . . . .	6

## **Chapter 2. Hardware Setup**

Rack Mounting . . . . .	9
Desktop Mount . . . . .	9
Using the Rack Mount Ears . . . . .	9
Installation . . . . .	11
Securing the Cable . . . . .	12

## **Chapter 3. Basic Operation and First Time Setup**

Operation Methods . . . . .	13
Browser . . . . .	13
eco DC . . . . .	13
SNMP . . . . .	13
First Time Setup . . . . .	14
Network Configuration . . . . .	15
Changing the Administrator Login . . . . .	15
Moving On . . . . .	16

## **Chapter 4. Browser Operation**

---

Logging In . . . . .	17
The eco PDU Main Page . . . . .	19
Page Components . . . . .	19
Energy . . . . .	20
Connections . . . . .	20
PDU Status . . . . .	20
Sensor Status . . . . .	21
Outlet Status . . . . .	21
Configuration . . . . .	23
Power On Time Schedule Settings . . . . .	23
Buzzer Setting . . . . .	23
Outlet Configuration . . . . .	23
Heartbeat . . . . .	27
Create a New Target . . . . .	28
Monitor, Edit, and Delete a Target . . . . .	29
User . . . . .	31
Administrator Information . . . . .	32
SNMPv3 Account Information . . . . .	32
SNMPv1/v2c Community . . . . .	32
Telnet . . . . .	32
SSH . . . . .	32
User Information . . . . .	32
Log . . . . .	34
System Log . . . . .	34
Notification Settings . . . . .	35
Setup . . . . .	37
Device Configuration . . . . .	37
General . . . . .	37
Service Ports . . . . .	38
IPv4 Configuration . . . . .	39
Event Notification . . . . .	40
Date/Time . . . . .	43
Finishing Up . . . . .	44
Security . . . . .	45
Login Failures . . . . .	45
Working Mode . . . . .	45
TLS Support . . . . .	46
IPInstaller Setting . . . . .	46
Session Timeout . . . . .	46
Account Policy . . . . .	47
IP Filter / Mac Filter . . . . .	47
Authentication & Authorization . . . . .	50
Private Certificate . . . . .	51
EcoTCP . . . . .	52
Scheduler . . . . .	53
Mail Control . . . . .	55

---

Mail Client .....	55
Receive Mail Server .....	56
Send Mail Server .....	56
Commands Sent by Email .....	57
PDU .....	58
Upgrade Main Firmware .....	58
Firmware File .....	58
Backup/Restore .....	60
Station List .....	60
Backup .....	60
Restore .....	61

**Chapter 5.Telnet Commands**

Remote Terminal Operations .....	63
Telnet .....	63
Setup .....	63
Logging In .....	64
Session Timeout .....	65
Commands .....	66
Verification .....	66
Read Power Outlet Status .....	67
Switch Outlet Status .....	68
Read Environmental Value .....	70
Close Telnet Session .....	71
Reboot PDU Device .....	72
Reset All PDU Config to Default Value .....	72

**Appendix**

Safety Instructions .....	75
General .....	75
Rack Mounting .....	77
Administrator Login Failure .....	78
IP Address Determination .....	79
Method 1: .....	79
Method 2: .....	80
Method 3: .....	80
Technical Support .....	81
International .....	81
North America .....	81
Specifications .....	82
PE4104A .....	82
PE4104AJ .....	84
PE4104G .....	86
ATEN Standard Warranty Policy .....	88
Limited Hardware Warranty .....	88



---

## About This Manual

---

This user manual is provided to help you get the most from the IP Control Box. It covers all aspects of installation, configuration and operation for the following models:

Model Number	Product Name
PE4104A	100-120 V 15A 1U 4-Outlet PDU (NEMA)
PE4104AJ	100-120 V 15A 1U 4-Outlet PDU (NEMA)
PE4104G	100-240 V 10A 1U 4-Outlet PDU (IEC)

An overview of the information in the manual is provided below.

**Chapter 1, Introduction**, introduces you to the unit/system. It presents purpose, features and benefits are presented, and its front and back panel components are described.

**Chapter 2, Hardware Setup**, provides step-by-step instructions for setting up your installation, and explains some basic operation procedures.

**Chapter 3, Basic Operation and First Time Setup**, explains the procedures that the administrator employs to set up the IP Control Box network environment, and change the default username and password.

**Chapter 4, Browser Operation**, describes how to log in to the IP Control Box with an Internet browser, and explains the layout and components of the user interface.

**Chapter 5, Telnet Commands**, describes how to connect to and access the IP Control Box's using Telnet.

**An Appendix**, at the end of the manual provides technical and troubleshooting information.

---

### Note:

- ◆ Read this manual thoroughly and follow the installation and operation procedures carefully to prevent any damage to the unit and/or connected devices.
  - ◆ The product may be updated, with features and functions added, improved, or removed since the release of this manual. For an up-to-date user manual, visit <http://www.aten.com/global/en/>.
-

## **Conventions**

This manual uses the following conventions:

- |   |  |
|---|--|
| Monospaced  | Indicates text that you should key in.   |
| [ ]   | Indicates keys you should press. For example, [Enter] means to press the <b>Enter</b> key. If keys need to be chorded, they appear together in the same bracket with a plus sign between them: [Ctrl+Alt]. |
| 1.  | Numbered lists represent procedures with sequential steps.   |
| ◆   | Bullet lists provide information, but do not involve sequential steps.   |
| >   | Indicates selecting the option (on a menu or dialog box, for example), that comes next. For example, Start > Run means to open the <i>Start</i> menu, and then select <i>Run</i> .                         |
|  | Indicates critical information.  |

# Chapter 1

## Introduction

### Overview

---

Engineered to be an intelligent power distribution solution, the PE4104 IP Control Box ships with 4 power outlets in an IEC / NEMA socket configuration. It provides secure, centralized, intelligent, and remote power management of data center IT equipment to minimize the operating cost.

The PE4104 features the remote power control function, allowing users to control devices attached to the PDU at the PDU device level from practically any location via a TCP/IP connection. The power sequence design eliminates the risks for a power inrush to guarantee reliable operation and protects the overall system health. With the support for eco DC software, it provides an easy method for managing multiple devices, offering an intuitive and user-friendly Graphical User Interface that allows users to configure a PDU device and reboot the device in case any equipment lock-up occurs. The administrators can switch on/off or set a delay time for each power outlet or individual power outlets group whenever, wherever.

The PE4104 boasts a slim, compact form factor and supports desk mount as well as rack mount, ensuring easy installation in confined spaces. It is a smart power control box built for service or retail applications, such as digital signages and video walls, for edge computing devices, including routers, servers and cameras, or for any data center environments where the faultless power distribution to the equipment connected to the PDU is needed.

## Features

---

### Power Distribution

- ◆ Power Distribution
- ◆ Space saving slim form factor
- ◆ EC / NEMA power outlet
- ◆ Separates power for the unit's own power and its power outlets—user interface is still accessible even when an overload condition trips the device's circuit breaker

### Remote Access

- ◆ Remote power control via TCP/IP and a built-in 10/100 Ethernet port
- ◆ Network Interfaces: TCP/IP, UDP, HTTP, HTTPS, SSL, SMTP, ARP, NTP, DNS, SNMP V1&V2&V3, auto sense, Ping, Telnet, Modbus (Over TCP/IP)
- ◆ Works with web-based eco DC software
- ◆ Supports IMAP and POP3 email protocols - enables users to switch on / off PE4104's outlets via E-mail
- ◆ Schedule control

### Operation

- ◆ Local and Remote power outlet control (On, Off, Power Cycle) by individual outlets
- ◆ Power-on sequencing—users can set the power on sequence and delay time for each port to allow equipment to be turned on in a proper order
- ◆ Easy setup and operation via a browser-based user interface
- ◆ Receives the heartbeat signals of its connected devices from PMonitor regularly to ensure their normal operation and reboots them when no signal is being sent to it
- ◆ Outlet lock functionality – use of the front panel Power Control Button for the outlet can be disabled to prevent inadvertent button presses

### Security

- ◆ Two-level password security

- ◆ Strong security features include password protection and advanced encryption technologies—TLS1.2
- ◆ Remote authentication support: RADIUS

## Requirements

---

- ◆ Browsers accessing the IP Control Box unit must support 2048 and 4096 bit encryption.
- ◆ For cold booting of attached computers, the computer's BIOS must support *wake on LAN* or *System after AC Back*.
- ◆ For Safe Shutdown:
  - ◆ The computer must be running Windows (Windows 2000 or higher) or Linux.
  - ◆ The Safe Shutdown program (available by download from our website), must be installed and running on the computer.

## Optional Accessories

### Sensors

Sensors are optional accessories. You can use the IP Control Box unit without sensors. However, if you want to have complete energy management of an instrumented data center with the use of the IP Control Box, you would need to use eco DC software and install sensor to generate a complete energy-efficient data and chart. Higher sensor installation density is helpful to generate more accurate data. A sensor-enabled installation is required to generate a more complete energy-efficient data and chart. Higher sensor installation density is helpful to generate more accurate data. Available sensors are show in the table, below:

Sensor	Part Number
Temperature	EA1140
Temperature / Humidity	EA1240
Differential Pressure / Temperature	EA1340

### Sensor Management

Sensors can be managed via the IP Control Box's built-in graphical user interface (GUI) or with the eco DC software that can be downloaded from the ATEN website.

### Cable Holders

Cable holders are optional accessories. For added safety, use ATEN Lok-U-Plug cable holders to secure the cables from your attached devices in place on the eco PDU unit. Use only the ATEN Lok-U-Plug cable holders that have been specifically designed to work with the eco PDU. Using any other kind of cable securing device could be highly dangerous. For more information, see *Securing the Cable*, page 12.

Part Number	Description
2X-EA07	Lok-U-Plug Cable Holder (10 pcs)
2X-EA08	Lok-U-Plug Installation Tool (4 pcs)
2X-EA10	C14 EZ-Lok Plug Connector (10 pcs)
2X-EA13	C14 Smart-Lok Plug Connector (10 pcs)

# Components

PE4104G (Front)

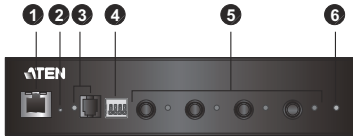

PE4104G (Rear)

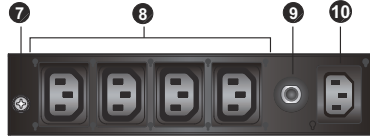

PE4104A / PE4104AJ (Front)

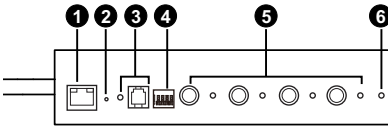

PE4104A / PE4104AJ (Rear)

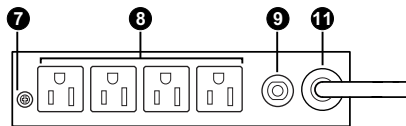

No.	Component	Description
1	LAN port	Connects the unit to the Internet via an Ethernet cable.
2	reset button (recessed)	Pin this button with a paper clip or ballpoint pen to reboot the unit. Pin and hold the button for more than 10 seconds to reset the device IP.
3	sensor port & LED	The external sensor plug into this RJ-11 port, and the sensor LED lights orange when a sensor is connected to the sensor port.
4	dry-contact port	The external door sensor plug into this door sensor dry - contact port.
5	power control buttons & LEDs	Each power control button (1 to 4), controls the power status of its corresponding AC output port as follow: <ul style="list-style-type: none"> <li>◆ Pressing and holding the button in for more than 3 seconds switches the power to its corresponding port on or off.</li> <li>◆ The LEDs light green to indicate that there is electricity going to its corresponding outlet.</li> </ul>
6	device power LED	The device power LED lights orange to indicate the unit is powered up and ready to operate.
7	grounding terminal	Connects to a suitable grounding object.
8	power outlet sockets	Electrical appliances plug in here.
9	circuit breaker	Protects the PDU from damage caused by excess current from an overload or short circuit.
10	power inlet	The power cord of the package content plugs in here.



<b>No.</b>	<b>Component</b>	<b>Description</b>
11	power cable	Power cord (attached) for the PE4104A / PE4104AJ.

This Page Intentionally Left Blank

# Chapter 2

## Hardware Setup



Important safety information regarding the placement of this device is provided on page 75. Please review it before proceeding.

### Rack Mounting

---

The IP Control Box can be mounted vertically on the outside of the rack and a few options are available.

#### Desktop Mount

If you wish to keep your unit on a desktop, attach the foot pads (in the package content) and place the unit on any appropriate level surface that can safely support its weight plus the weight of its attached cables.

#### Using the Rack Mount Ears

The following procedure uses PE4104G as an example to illustrate the installation.

1. Decide where you would rack mount the unit and choose the place you would attach the rack mount ear (Position 1, 2, 3, or 4). As an example, we will choose to attach the rack mount ear shown below (position 3).

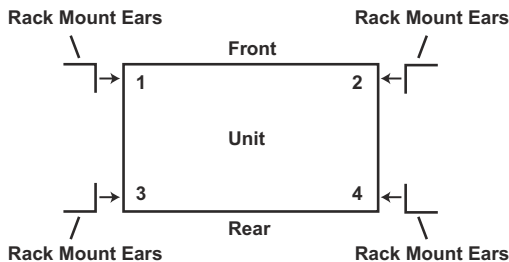

2. Align and stabilize the rack mount ear using M3 Phillips hex screws.

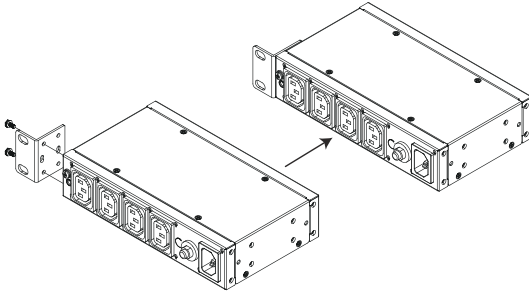

3. Align the unit and the rack mount ear to the rack and stabilize the unit using rack screws. Let the buttons stabilize in the button holes and the mounting is complete.

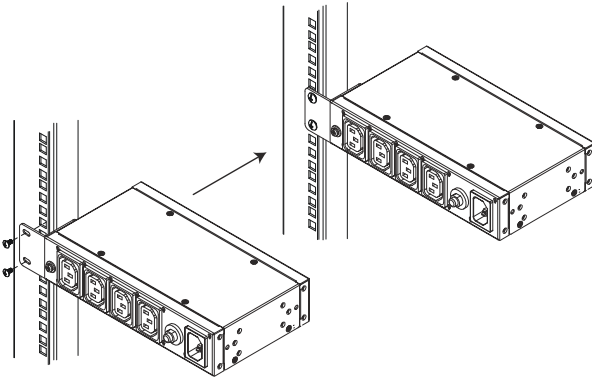

## Installation

To set up your IP Control Box installation, refer to the installation diagram and the procedure below. The PE4104A / PE4104AJ is used as an example to illustrate the installation.

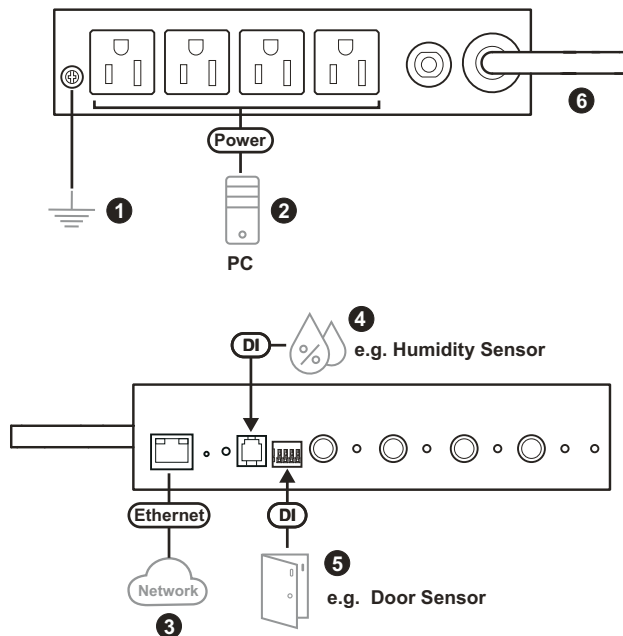

1. Ground the IP Control Box by connecting one end of a grounding wire to the grounding terminal and the other end to a suitable grounded object.

---

**Note:** Do not omit this step. Proper grounding helps prevent damage to the unit from power surges or static electricity.

---

2. For each device you want to connect, connect its power cable to any available outlet on the unit. Optionally, use ATEN Lok-U-Plug cable holders to secure the cables. For details, see *Securing the Cable*, page 12.
3. Connect an Internet-enabled LAN cable into the unit's LAN port.
4. (Optional) To use a temperature sensor, humidity sensor, or pressure sensor, connect it to the RJ-11 sensor port.
5. (Optional) To use a door sensor or a leak detector, connect it to the dry-contact port.

6. Supply the unit with power.
  - ◆ PE4104A / PE4104AJ: plug the power cord to an AC power source.
  - ◆ PE4104G: Use the provided power cord to connect the unit's power inlet socket to an AC power source.
7. Power on the connected devices.

## **Securing the Cable**

For added safety, use ATEN Lok-U-Plug cable holders to secure the cables from your attached devices in place onto the IP Control Box. Secure the cable holders using the specially designed holes around the individual power outlets, as shown below:

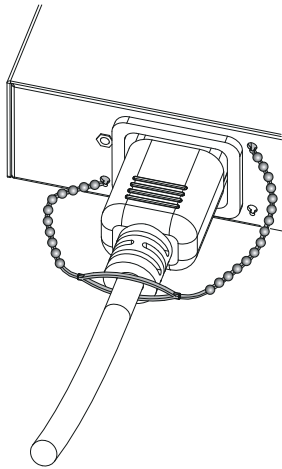

---

### **Note:**

- ◆ Lok-U-Plug Cable Holders and their Installation Tools are optional and sold separately. See *Cable Holders*, page 5.
  - ◆ Use only the ATEN Lok-U-Plug cable holders that have been specifically designed to work with the eco PDU. Using any other kind of cable securing device could be highly dangerous.
-

# Chapter 3

## Basic Operation and First Time Setup

### **Operation Methods**

---

The IP Control Box provide three methods to access and manage your installation: Browser, eco DC Energy Management Software and SNMP.

---

**Note:** The following sections of this chapter contain information concerning Browser operation. For eco DC operation, please refer to the separate eco DC User Manual. The eco DC software and User Manual can be downloaded from the ATEN website.

---

#### **Browser**

The IP Control Box can be accessed and controlled via any supported Internet browser from any platform. See *First Time Setup*, page 14, and the following sections in this chapter, for full details.

#### **eco DC**

The eco DC Energy Management Software. eco DC provides you with an easy method for managing multiple devices, offering an intuitive and user-friendly Graphical Interface that allows you to configure a PDU device and monitor power status of the equipment connected to it. eco DC Energy Management Software can be downloaded from the ATEN website, along with a separate eco DC User Manual.

#### **SNMP**

The eco PDU supports any 3rd party V3 SNMP Manager Software. SNMP Management Information Database (MIB) files for the eco PDU device can be found on the software.

## First Time Setup

Once the eco PDU installation has been cabled up, the next task the administrator needs to perform involve configuring the network parameters, changing the default super administrator login settings, and adding users.

The way to accomplish this is to log in via web browser.

- Note:** 1. Since this is the first time you are logging in, use the default username: *administrator*; and the default password: *password*. For security purposes we recommend changing them to something unique (see *Changing the Administrator Login*, page 15).
2. For remote methods of getting logged in to the PDU, see *IP Address Determination*, page 79.

After you successfully log in, the eco PDU Energy/Connections page appears:

The screenshot shows the ATEN PE4104AJ web interface. The top navigation bar includes 'Energy', 'User', 'Log', 'Setup', and 'PDU' tabs. The main content area is titled 'Connections' and shows a 'Station List' on the left with a tree view containing 'PE4104AJ' and its sub-items '01', '02', '03', and '04'. The main display area is divided into three sections:

- PDU Status:** A table with columns: PDU Name, Measurement, Min Threshold, Max Threshold, and PDU Status.
 

PDU Name	Measurement	Min Threshold	Max Threshold	PDU Status
PE4104AJ	Breaker	ON		<input checked="" type="radio"/> ON <input type="checkbox"/> Reboot <input type="checkbox"/> OFF
	Door Sensor	N/A		

Below the table, 'Door Sensor Type' options are listed:
 
  - Not Installed
  - Photo (EA1440)
  - Inductive Proximity (EA1441)
  - Reed (EA1442)
  - Water Leakage Sensor (EA1540)
- Sensor Status:** A table with columns: Sensor Port, Address, Temperature, Humidity, and Pressure.
 

Sensor Port	Address	Temperature	Humidity	Pressure
Sensor1	1	N/A	N/A	N/A
- Outlet Status:** A table with columns: Outlet, Outlet Name, Auto Ping Status, Outlet Status, and Outlet Switching.
 

Outlet	Outlet Name	Auto Ping Status	Outlet Status	Outlet Switching
01		N/A	ON	<input checked="" type="radio"/> ON <input type="checkbox"/> Reboot <input type="checkbox"/> OFF

At the bottom of the interface, there is a copyright notice: © Copyright 2022 ATEN @ International Co., Ltd.

- Note:** Operation details are discussed in *Energy*, page 20, in the next chapter. For further setup information, continue with this chapter



## Network Configuration

To configure the network settings, do the following:

1. Click the **Setup** tab.
2. The interface displays the **Device Configuration** page. A screen similar to the one below appears:

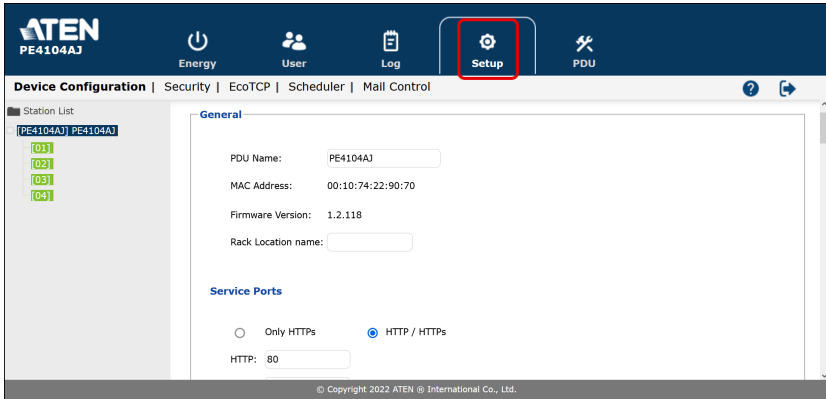

3. Fill in the fields according to the information provided under *Device Configuration*, page 37.

## Changing the Administrator Login

To change the default administrator username and password, do the following:

1. Click the **User** tab.

The *Accounts* page has a detailed list of users—with more information about them—in the large central panel:

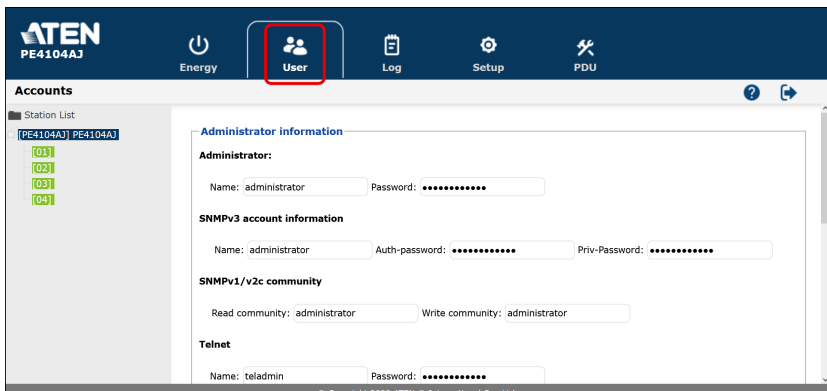

2. In the **Administrator Information** section, reset the name and password fields to something unique, then click **Save** (at the bottom of the page.)

---

**Note:** If you forget the administrator's name or password, short the mainboard jumper to restore the default administrator account. See *ATEN Standard Warranty Policy*, page 88 in the Appendix for full details.

---

## Moving On

---

After setting up the network and changing the default administrator username and password, you can proceed to other administration activities—including adding users. This is covered in the next chapter.

# Chapter 4

## Browser Operation

### Logging In

---

The IP Control Box can be accessed via a supported Internet browser from any platform.

---

**Note:** Browsers must support SSL 2048 and 4096 bit encryption.

---

To access the IP Control Box do the following:

1. Open your browser and specify the IP address of the IP Control Box you want to access in the browser's URL location bar.
- 

**Note:** You can get the IP address from the administrator, or see *IP Address Determination*, page 79, for information about setting it up yourself.

---

2. If a Security Alert dialog box appears, accept the certificate—it can be trusted. The Login page appears:

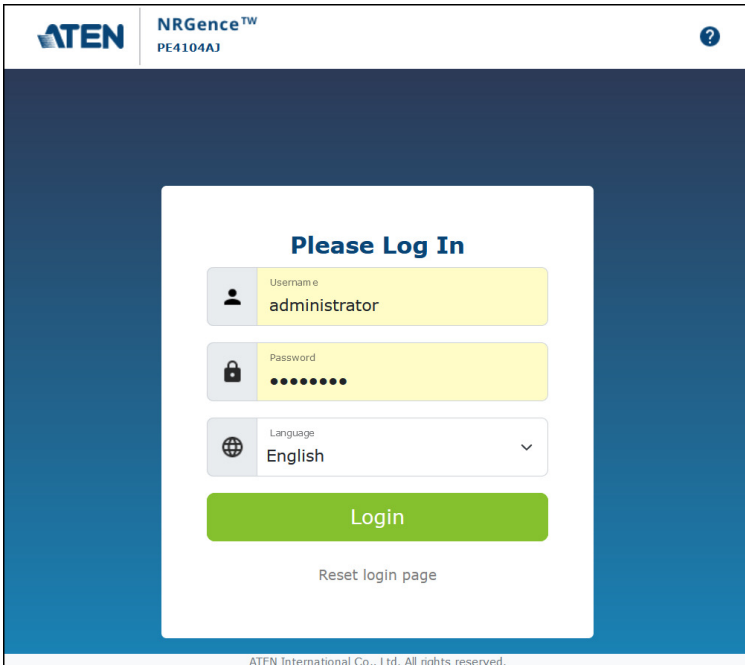

ATEN NRGence™ PE4104AJ

### Please Log In

Username  
administrator

Password  
••••••••

Language  
English

Login

[Reset login page](#)

ATEN International Co., Ltd. All rights reserved.

3. Provide a valid username and password (set by the administrator), and select your language. (Options are: English [default]; Traditional Chinese; Simplified Chinese; Japanese; German; Italian; Spanish; French; Russian; Korean; Portuguese).
4. Click **Login** to bring up the browser Main Page.

## The eco PDU Main Page

After you have successfully logged in, the IP Control Box Main Page comes up with the Energy *Connections* page displayed:

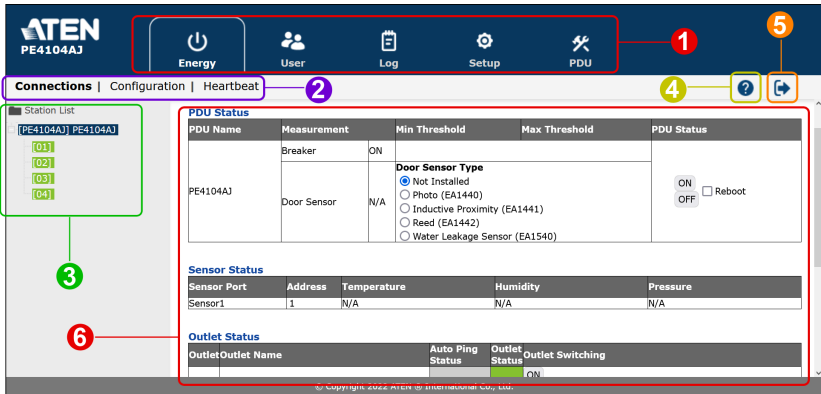

**Note:** The screen depicts an administrator's page. Depending on a user's type and permissions, not all of these elements appear.

### Page Components

The web page screen components are described in the table, below:

No.	Item	Description
1	Tab Bar	The tab bar contains the IP Control Box's main operation categories. The items that appear in the tab bar are determined by the user's type, and the authorization options that were selected when the user's account was created.
2	Menu Bar	The menu bar contains operational sub-categories that pertain to the item selected in the tab bar. The items that appear in the menu bar are determined by the user's type, and the authorization options that were selected when the user's account was created.
3	Sidebar	The Sidebar provides a tree view listing of outlets that relate to the various tab bar and menu bar selections.
4	Help	Connects to on-line help at the ATEN website for the device's configuration and operation.
5	Logout	Click this button to log out of your IP Control Box session.
6	Interactive Display Panel	This is your main work area. The screens that appear reflect your menu choices and Sidebar node selection.

# Energy

## Connections

When you log in to the IP Control Box, the interface opens with its default selection of the *Energy* tab; and the *Connections* menu. The contents of the **PDU Status**, **Sensor Status**, and **Outlet Status** sections are displayed in the main panel.

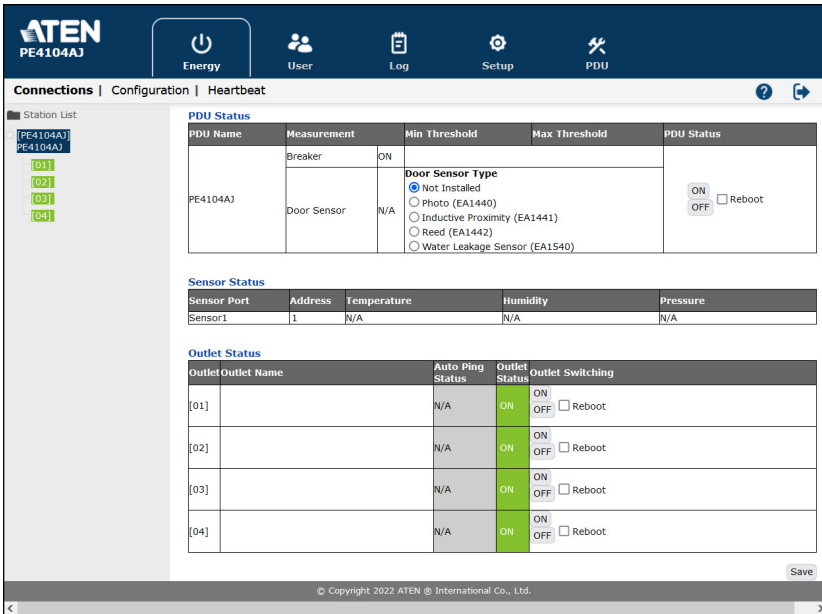

## PDU Status

The IP Control Box supports PDU device level monitoring. The **PDU Status** section allows you to set up a power management configuration for the PDU device as a whole:

PDU Name	Measurement	Min Threshold	Max Threshold	PDU Status
PE4104AJ	Breaker	ON		<input checked="" type="radio"/> ON <input type="radio"/> OFF <input type="checkbox"/> Reboot
	Door Sensor	N/A		

**Door Sensor Type**

- Not Installed
- Photo (EA1440)
- Inductive Proximity (EA1441)
- Reed (EA1442)
- Water Leakage Sensor (EA1540)

- ◆ **Breaker On / Off**

This field indicates the breaker status.

**On:** Breaker status is normal

**Off:** Breaker is switched off and you have to manually switch the breaker to **On**.

♦ **Door Sensor Type**

You can choose a door sensor type for the connected door sensor by checking the available radio buttons.

♦ **On / Off / Reboot**

You can manually turn the device On and Off from this page by clicking the buttons. To Reboot the device, enable the Reboot checkbox and click on **Off**.

## Sensor Status

If you have sensors installed in your installation, use these fields to set the maximum, minimum and fluctuation threshold settings for Temperature, Humidity, and Differential Pressure.

Make sure to click Save button (located at the bottom of the page) once you

### Sensor Status

Sensor Port	Address	Temperature	Humidity	Pressure
Sensor1	1	N/A	N/A	N/A
	Max Threshold	40		
	Min Threshold	0		

have finished making your Sensor Status settings.

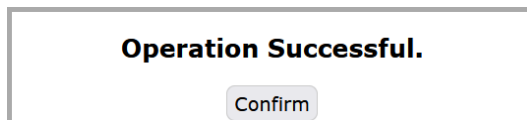

---

**Note:** Sensors are optional accessories. Check with your dealer for information about eco DC software.

---

## Outlet Status

The IP Control Box supports on, off and reboot control from the outlet status column for each outlet.

**Outlet Status**

Outlet	Outlet Name	Auto Ping Status	Outlet Status	Outlet Switching
[01]		N/A	ON	ON OFF <input type="checkbox"/> Reboot
[02]		N/A	ON	ON OFF <input type="checkbox"/> Reboot
[03]		N/A	ON	ON OFF <input type="checkbox"/> Reboot
[04]		N/A	ON	ON OFF <input type="checkbox"/> Reboot

◆ **On / Off / Reboot**

You can manually turn the outlet On and Off from this page by clicking the buttons. To Reboot the outlet, enable the Reboot checkbox and click on Off.



## Configuration

The *Configuration* page is used to configure the settings of the IP Control Box at the individual power outlet level.

### Power On Time Schedule Settings

Enable Power On Time Schedule

### Buzzer Setting

Enable Buzzer Alarm

## Power On Time Schedule Settings

Check the **Enable Power On Time Schedule** box to use the *Power ON Delay* setting to set the amount of time the eco PDU waits before powering on an outlet. See *Power ON Delay* in the table on the next page.

## Buzzer Setting

Checking the **Enable Buzzer Alarm** box sounds an alarm and sends SNMP trap or e-mail alerts when a threshold setting exceeds the minimum or maximum setting.

## Outlet Configuration

The *Outlet Configuration* section lets you set the power management settings for each outlet on the PDU.

### Outlet Configuration

Outlet	Outlet Name	Confirmation Required	Outlet Locked	Delay Time (sec)		Remote Turn ON Method	Autoping Monitoring
				Power ON	Power OFF		
[01]		<input type="checkbox"/>	<input type="checkbox"/>	5	1	Method: Kill the Power MAC Address: 000000000000	<input type="radio"/> Enable Outlet control: Ping Interval: Wait time before Consecutive failed
[02]		<input type="checkbox"/>	<input type="checkbox"/>	5			<input type="radio"/> Enable <input checked="" type="radio"/> Disable Outlet control: <input type="radio"/> Enable <input checked="" type="radio"/> Disable Ping Interval: 60 sec(s) Wait time before first ping: 10 sec(s) Consecutive failed pings (Reboot outlet): 1 time(s) Max outlet reboot times: 1 time(s) IP Address: 0.0.0.0

Control/Display	Description
Outlet	Shows the port number of the listed outlet.
Outlet Name	Each outlet can be given a distinctive name. The maximum number of characters is 48.
Confirmation Required	If this option is enabled (there is a check in the checkbox), a dialog box comes up asking you to confirm a power operation before it is performed. If it is disabled (there is no check in the checkbox), the operation is performed without confirmation.
Outlet Locked	To lock the power control buttons on the unit to prevent accidental button press, enable this function by checking the checkbox and then click on <b>Save</b> (located at the bottom of the page). See <i>power control buttons &amp; LEDs</i> , page 6.
Delay Time (sec) Power ON	Sets the amount of time the eco PDU waits after the Power Button is clicked (see <i>Outlet Status</i> , page 21), before it turns on the power to the outlet. You must check the <i>Enable Power On Time Schedule Setting</i> box for this setting to take effect. See <i>Power On Time Schedule Settings</i> , page 23, for details. <b>Note:</b> The default delay time is 1 seconds; the maximum is 999 seconds. When a series of outlets are scheduled to be powered up, they turn on in sequence with a default delay of 10 milliseconds between each outlet.
Delay Time (sec) Power OFF	Sets the amount of time the eco PDU waits after the Power Button is clicked (see <i>Outlet Status</i> , page 21), before it turns off the power to the outlet. For the <i>System after AC Back</i> option (see below), after the delay time expires, the eco PDU waits another fifteen seconds, then shuts the computer down. The default delay time is 5 seconds. The maximum delay time is 999 seconds.

Control/Display	Description
Remote Turn ON Method	<p>Use the drop-down menu to select one of the choices, below:</p> <ul style="list-style-type: none"> <li>◆ <b>Wake on LAN</b> <p>This is a Safe Shutdown and Restart option. If this is selected, when an Outlet is turned Off, the eco PDU first sends a message to the computer telling it to prepare for a shutdown; it then waits for the amount time set in the <i>Power Off Delay</i> field to give the OS time to close down before the computer is powered down to standby mode.</p> <p>Likewise, when the Outlet is turned On, the eco PDU waits for the amount time set in the <i>Power On Delay</i> field, then sends an Ethernet message to the computer connected to the Outlet telling the computer to turn itself On.</p> <p><b>Note:</b> For Safe Shutdown and Restart, the computer must be running Windows (98 or higher), or Linux, and the <i>Safe Shutdown</i> program (available by download from our website), must be installed and running on the computer.</p> </li> <li>◆ <b>System after AC Back</b> <p>This is a Safe Shutdown and Restart option. If this is selected, when an Outlet is turned Off, the eco PDU first sends a message to the computer telling it to prepare for a shutdown; it then waits for the amount time set in the <i>Power Off Delay</i> field to give the OS time to close down before the computer is powered down.</p> <p>When the Outlet is turned On, the eco PDU waits for the amount time set in the <i>Power On Delay</i> field, then sends power to the server. When the server receives the power, it turns itself on.</p> <p><b>Note:</b> For Safe Shutdown and Reboot, the computer must be running Windows (98 or higher), or Linux, and the <i>Safe Shutdown</i> program (available by download from our website), must be installed and running on the computer.</p> </li> <li>◆ <b>Kill the Power</b> <p>If this option is selected, the eco PDU waits for the amount time set in the <i>Power Off Delay</i> field, and then turns the Outlet's power Off. Turning the power off performs a cold (non-safe) shutdown.</p> </li> </ul>
MAC Address	<p>In order to use either of the Safe Shutdown and Restart methods the MAC address of the computer connected to the outlet must be filled in here.</p>

Control/Display	Description
Autoping Monitoring	<p><i>Autoping Monitoring</i> defines the mechanism which the IP Control Box uses to ping a device and to reboot the outlet. To enable this setting, select the <b>Enable</b> radio button, or select the <b>Disable</b> radio button to disable.</p> <ul style="list-style-type: none"><li>◆ <b>Outlet control</b> Enable this setting to reboot the outlet when the IP Control Box fails to ping the device for the specified number of times, as set in the <b>Consecutive failed pings (Reboot outlet)</b> field.</li><li>◆ <b>Ping interval</b> Enter the number of seconds to elapse between each auto-ping that is sent to test the network device.</li><li>◆ <b>Wait time before first ping</b> Enter the duration to wait before the outlet is powered on during a reboot.</li><li>◆ <b>Consecutive failed pings (Reboot outlet)</b> Enter the maximum number of times that the IP Control Box pings the specified device after an initial failure.</li><li>◆ <b>Max outlet reboot times</b> Enter the maximum number of times that the IP Control Box reboots the specified device after the consecutive pings, as specified in the <b>Consecutive failed pings (Reboot outlet)</b> field.</li><li>◆ <b>IP Address</b> Enter the IP address of the device you want to ping.</li></ul>

When you have finished making your configuration settings, click **Save**.

**Operation Successful.**

Confirm

## Heartbeat

The *Heartbeat* page helps you to monitor the connected devices by setting your target device(s) to send the data packet to the IP Control Box. You can define the mechanisms to instruct the IP Control Box to monitor the connected device(s) and control when the outlet(s) is rebooted.

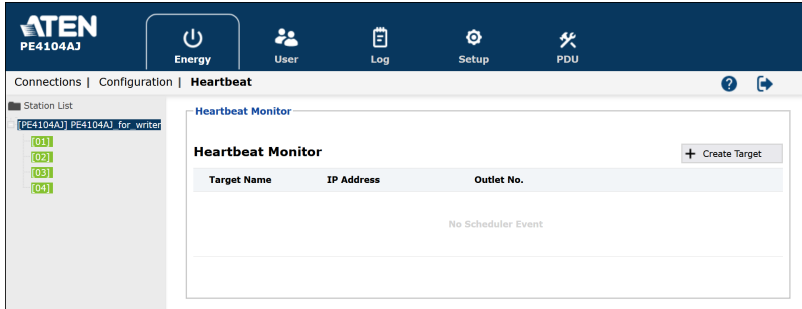

Make sure to install the ATEN utility, Power Monitor, to your PC before configuring **Heartbeat Monitor** settings. You can download the Power Monitor installer from the *Support and Downloads* tab of the product page.

Software & Drivers ▾				
OS	Description	Ver.	Release Date	File Name
<a href="#">Other</a>				
Linux	PMonitor	v1.1.107	2013-03-08	<a href="#">PMonitor_linux_v1.1.107.zip</a>
Windows	PMonitor	v1.0.081	2012-02-10	<a href="#">PMonitorSrv_v1.0.081.zip</a>

## Create a New Target

To create a new target, click on the **+Create Target** button to enter *Create Target* page, and fill in the following fields:

**← Create Target**

**Target Name**

**Action** Reboot Outlet   time(s)

**Interval (sec)**

**Target Reboot Duration (sec)**

**Timeout Threshold (counts)**

**IP Address**

Item	Description
Target Name	Enter the name for the target device.
Action	Select the outlet to be rebooted, and define how many times you'd like to reboot the selected outlet. "None" means no outlet will be rebooted.
Interval (sec)	Set the period between two data packets receive events.
Target Reboot Duration (sec)	Set the delay time to instruct the IP Control Box to wait after the selected outlet is successfully rebooted. The IP Control Box will not start to receive data packets from the target device till the delay time is reached.
Timeout Threshold (counts)	Determine the number of times that the IP Control Box performs the action "Interval (sec)" and receives no data packets before rebooting the selected outlet.
IP Address	Enter the IP address of the target device.
Cancel / Save	Click on Save button to finish your settings, or click on Cancel button to discard the changes.

Save your settings, and now the target is created and listed on the *Heartbeat Monitor* list.

**Heartbeat Monitor**

+ Create Target

Target Name	IP Address	Outlet No.		
TEST	10.3.52.50	1	Online	<input checked="" type="checkbox"/>

## Monitor, Edit, and Delete a Target

*Heartbeat Monitor* list delivers the following information:

Item	Description
Target Name	The name of the target device
IP Address	The IP address of the target device
Outlet No.	The outlet you selected to reboot once the criteria are triggered
Online / Offline	The status of the target device
Switch	The switch button to enable or disable the control and monitoring mechanisms

To edit or delete a target, click on the target to be edited to enter the *Edit Target* page.

**← Edit Target** Delete

**Target Name**

**Action** Reboot Outlet   time(s)

**Interval (sec)**

**Target Reboot Duration (sec)**

**Timeout Threshold (counts)**

**IP Address**

On the *Edit Target* page, you may:

- ◆ Make changes of the settings and click on **Save** button to apply the changed settings.
- ◆ Click on **Cancel** button to discard your changed settings.
- ◆ Click on **Delete** button to remove the target from *Heartbeat Monitor* list.



## User

When you select the *User* tab the screen comes up with *Administrator Information* and *User Information* displayed in the main panel. The IP Control Box supports one administrator account and up to eight user accounts.

- Note:**
1. Each account can support 2 login sessions.
  2. The IP Control Box supports a total of 3 concurrent login sessions.

**Administrator information**

**Administrator:**

Name:  Password:

**SNMPv3 account information**

Name:  Auth-password:  Priv-Password:

**SNMPv1/v2c community**

Read community:  Write community:

**Telnet**

Name:  Password:

**SSH**

Name:  Password:

**User information**

ManagementName	Password	Outlet				
		All	01	02	03	04
Disable ▾		<input checked="" type="checkbox"/>	<input checked="" type="checkbox"/>	<input checked="" type="checkbox"/>	<input checked="" type="checkbox"/>	<input checked="" type="checkbox"/>
Disable ▾		<input checked="" type="checkbox"/>	<input checked="" type="checkbox"/>	<input checked="" type="checkbox"/>	<input checked="" type="checkbox"/>	<input checked="" type="checkbox"/>
Disable ▾		<input checked="" type="checkbox"/>	<input checked="" type="checkbox"/>	<input checked="" type="checkbox"/>	<input checked="" type="checkbox"/>	<input checked="" type="checkbox"/>
Disable ▾		<input checked="" type="checkbox"/>	<input checked="" type="checkbox"/>	<input checked="" type="checkbox"/>	<input checked="" type="checkbox"/>	<input checked="" type="checkbox"/>
Disable ▾		<input checked="" type="checkbox"/>	<input checked="" type="checkbox"/>	<input checked="" type="checkbox"/>	<input checked="" type="checkbox"/>	<input checked="" type="checkbox"/>
Disable ▾		<input checked="" type="checkbox"/>	<input checked="" type="checkbox"/>	<input checked="" type="checkbox"/>	<input checked="" type="checkbox"/>	<input checked="" type="checkbox"/>
Disable ▾		<input checked="" type="checkbox"/>	<input checked="" type="checkbox"/>	<input checked="" type="checkbox"/>	<input checked="" type="checkbox"/>	<input checked="" type="checkbox"/>
Disable ▾		<input checked="" type="checkbox"/>	<input checked="" type="checkbox"/>	<input checked="" type="checkbox"/>	<input checked="" type="checkbox"/>	<input checked="" type="checkbox"/>

Save

**Note:** There is a pre-installed administrator account. It can be used to set up the device and to begin creating users. The username for this account is *administrator*; the password is *password*. For security purposes, we strongly recommend changing these to something unique.

## **Administrator Information**

This section is used to set the administrator name and password. Only administrators can view this section. For details, see *Changing the Administrator Login*, page 15.

### **SNMPv3 Account Information**

- ◆ Enter values for **Name**, **Auth-Password** and **Priv-Password** for SNMPv3 authentication, if required.

### **SNMPv1/v2c Community**

- ◆ Enter values **Read community** and **Write community** for SNMPv1/V2c authentication, if required.

### **Telnet**

- ◆ Use the **Name** and **Password** fields to change the account used to login via Telnet sessions.

### **SSH**

- ◆ Enter values in the required fields to change the account used to login via SSH.

When you have finished making your configuration settings, click **Save**.

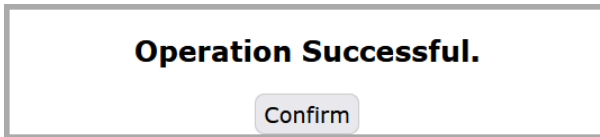

## **User Information**

To add a user, do the following:



1. Select the Enable or Disable in the Management drop-down menu.
2. Key in a name and password in the Name and Password fields.
3. Set the outlet-by-outlet permissions of the user in the Outlet field.
4. Click *Save* to save your settings.

---

**Note:** Values must be entered in both the Name and Password fields in order to enable an account.

---

The various options are explained in more detail in the following table:

Field	Description
Management	The Management field allows you to Enable or Disable a user's account: <ul style="list-style-type: none"> <li>◆ Enable: Stores the user account (see <i>User Information</i>, page 32)</li> <li>◆ Disable: Disables the user account</li> </ul>
Name	From 1 to 16 characters are allowed depending on the Account Policy settings. See <i>Account Policy</i> , page 47.
Password	From 1 to 16 characters are allowed depending on the Account Policy settings. See <i>Account Policy</i> , page 47.
Outlet	This field allows you to set the outlet-by-outlet permissions of the user. Click on the user/port icon to cycle through the three permissions options, as follows:
	 User has complete access to this outlet.
	 User has read-only access to this outlet.
 User has no access to this outlet.	

When you have finished making your configuration settings, click **Save**.

**Operation Successful.**

Confirm

## Log

The *Log* tab keeps a record of transactions that take place on its installation, and stores up to 1024 events at one time. The *System Log* page provides a powerful array of filters and functions that allow you to view and export the log file data, as well as be informed by email of specified events as they occur.

Refresh  Event(s) per Page Page 1 of 2

No.	Date/Time	Category	Severity	User	Description
00001	1970-01-04 10:30:41	Authentication Information	Information	administrator	administrator 10.3.66.84 logged in
00002	1970-01-01 18:52:05	Authentication Information	Information	administrator	administrator 10.3.66.84 session timed out
00003	1970-01-01 13:30:04	Authentication Information	Information	administrator	administrator 10.3.66.84 logged in
00004	1970-01-01 13:11:49	Authentication Information	Information	administrator	administrator 10.3.66.84 session timed out
00005	1970-01-01 11:02:50	Authentication Information	Information	administrator	administrator 10.3.66.84 logged in
00006	1969-12-31 19:00:53	Authentication Information	Information	administrator	administrator 10.3.66.84 session timed out
00007	1969-12-31 18:26:23	Device	Information	System	Outlet 1 was turned ON
00008	1969-12-31 18:26:17	Device	Information	administrator	ON command issued to Outlet 1 by administrator
00009	1969-12-31 18:26:16	Device	Information	System	Outlet 1 was turned OFF
00010	1969-12-31 18:26:14	Device	Information	administrator	OFF command issued to Outlet 1 by administrator
00011	1969-12-31 18:21:45	Device	Information	administrator	Sensor port:1 addr:1 min environmental temperature threshold was modified
00012	1969-12-31 18:21:45	Device	Information	administrator	Sensor port:1 addr:1 max environmental temperature threshold was modified
00013	1969-12-31 18:13:58	Device	Information	administrator	Dry contact port:1 was changed by administrator
00014	1969-12-31 17:53:58	Device	Information	administrator	Dry contact port:1 was changed by administrator
00015	1969-12-31 17:53:33	Device	Information	administrator	Dry contact port:1 was changed by administrator
00016	1969-12-31 17:53:20	Authentication Information	Information	administrator	administrator 10.3.66.84 logged in
00017	1969-12-31 17:53:06	Authentication Information	Information	administrator	administrator 10.3.66.84 logged out

## System Log

- ◆ Clicking on a device in the Sidebar displays its log events in the main panel's log event list.
- ◆ Clicking the **Refresh** button brings the log list up to date with the latest events.
- ◆ The entry box to the right of the Refresh button lets you set the number of events to display per page. Simply key in the number of your choice.
- ◆ The top right of the main panel shows the total number of pages in the log file, and what page you are currently viewing.
- ◆ The buttons on the bottom row function as follows:
  - ◆ **Clear:** Click to erase the contents of the log event list
  - ◆ **First Page:** Click to go to the first page of the log event list
  - ◆ **Previous Page:** Click to move to the previous page of the log event list

- ◆ **Next Page:** Click to move to the next page of the log event list
- ◆ **Last Page:** Click to move to the last page of the log event list
- ◆ **Save:** Click to save the contents of the log event list to file. Select .csv or .txt type, can click **Save**.

Select the type of file to export the logs.

.Csv File

.Txt File

## Notification Settings

The *Notification Settings* page is used to specify which of the IP Control Box's components will receive notification of a log event. When you click the Notification Settings menu item, a page similar to the one below appears:

**Event Log Settings**

Event List			
Event	Syslog	E-mail	SNMP
> <b>Enable all system events</b>	✓	✓	✓
∨ <b>Enable all Authentication events</b>	✓	✓	✓
User login	✓	✓	✓
User login failure	✓	✓	✓
User logout	✓	✓	✓
Session timeout	✓	✓	✓
User locked	✓	✓	✓
User unlocked	✓	✓	✓
∨ <b>Enable all User Management events</b>	✓	✓	✓
Outlet port setting modified	✓	✓	✓
User added	✓	✓	✓
User deleted	✓	✓	✓
User account modified	✓	✓	✓
User access right(outlet) modified	✓	✓	✓
External authentication failed	✓	✓	✓
> <b>Enable all Device Management events</b>	✓	✓	✓

- ◆ The event categories are listed in the left column.
  - ◆ When you first open the page, only the main category items appear. (Main category item rows have a gray background.)

- ◆ Sub-category items are nested under the main category headings. Click the arrow in front of the main category headings to display the subcategory items. (Sub-category item rows have a white background.)
- ◆ Click the checkboxes under the column headings to select which component(s) will receive notification of the log events.
  - ◆ Clicking on a main category heading's row automatically selects all the sub-category items nested below it.
  - ◆ If you only want to set notification for some of the sub-category events, don't put a check in the main category row. Instead, drop down the sub-category list, and only check the sub-category events you want.
- ◆ When you have finished making your setting choices, click Save. When a specified log event occurs, notification of that event will be sent to the selected component.
- ◆ Reset Digital Output: If an event has been triggered that changes the digital output sensor from Low to High, click this button to return the sensor to the Low state.

When you have finished making your configuration settings, click **Save**.

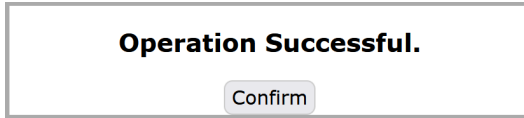

## Setup

The *Setup* tab provides Device Configuration and Security settings. The *Device Configuration* page allows administrators to configure the IP Control Box's system settings. The *Security* page controls access to the PDU.

### Device Configuration

This page presents information about the selected device, as described in the following sections:

#### General

**General**

PDU Name:

MAC Address: 00:10:74:22:90:70

Firmware Version: 1.2.118

Rack Location name:

Item	Meaning
PDU Name	This field lets you give the device a unique name. Simply delete whatever is in the text box and key in the name of your choice. Click <b>Save</b> (located at the bottom of the page) to save the new name.
MAC Address	This item displays the IP Control Box's MAC address.
Firmware Version	This item displays the current firmware version number. You can reference it to see if there are newer versions available on the ATEN website.
Rack Location Name	This field lets you give the rack location a unique name for easy reference.

## Service Ports

As a security measure, if a firewall is being used, the administrator can specify the port numbers that the firewall will allow. If a port other than the default is used, users must specify the port number as part of the IP address when they log in. If an invalid port number (or no port number) is specified, the IP Control Box will not be found.

Select whether to allow only secure browser logins, as show below:

**Service Ports**

Only HTTPs       HTTP / HTTPS

HTTP:

HTTPS:

An explanation of the fields is given in the table below:

Field	Explanation
HTTP	The port number for a browser login. The default is 80.
HTTPS	The port number for a secure browser login. The default is 443.

- 
- Note:**
1. Valid entries for all of the Service Ports are from 1 to 65535.
  2. The service ports cannot have the same value. You must set a different value for each one.
  3. If there is no firewall (on an Intranet, for example), it doesn't matter what these numbers are set to, since they have no effect.
-



## IPv4 Configuration

The PDU's IPv4 IP and DNS addresses (the traditional method of specifying IP addresses) can either be assigned dynamically (DHCP), or a fixed IP address can be specified.

### IPv4 Configuration

**Ethernet1**

Obtain IP address automatically [DHCP]

Set IP address manually [Fixed IP]

IP Address:

Subnet Mask:

Default Gateway:

Obtain DNS server address automatically

Set DNS server address manually

Preferred DNS Server:

Alternate DNS Server:

- ◆ For dynamic IP address assignment, select the *Obtain IP address automatically* radio button. (This is the default setting.)
- ◆ To specify a fixed IP address, select the *Set IP address manually* radio button and fill in the IP address with values appropriate for your network.
- ◆ For automatic DNS Server address assignment, select the *Obtain DNS Server address automatically* radio button.
- ◆ To specify the DNS Server address manually, select the *Set DNS server address manually* radio button, and fill in the addresses for the Preferred and Alternate DNS servers with values appropriate for your network.

---

**Note:** 1. If you choose *Obtain IP address automatically*, when the device starts up it waits to get its IP address from the DHCP server. If it hasn't obtained the address after one minute, it automatically reverts to its factory default IP address (192.168.0.60.)

2. If the device is on a network that uses DHCP to assign network addresses, and you need to ascertain its IP address, see *IP Address Determination*, page 79, for information.
  3. Specifying the Alternate DNS Server address is optional.
- 

## Event Notification

The Event Notification section is divided into three sections: SMTP Server; SNMP Trap Receivers; and Syslog Server. Each section is described below.

### ◆ SMTP Server

**Event Notification**

**SMTP Server**

Enable report from the following SMTP Server

SMTP Server:

SMTP Port Number:

Server requires authentication

Account Name:

Password:

Enable secure connection (STARTTLS)

From:

To:

To have the IP Control Box email reports from the SMTP server to you, do the following:

1. Enable the *Enable report from the following SMTP Server*, and key in the IP address and Port number of your SMTP server.
2. If your server requires authentication, put a check in the *My server requires authentication* checkbox.
3. Key in the appropriate account information in the *Account Name*, *Password*, and *From* fields.

---

**Note:** Only one email address is allowed in the *From* fields, and it cannot exceed 64 characters.

---

4. Key in the email address (addresses) of where you want the event reports sent to in the *To* field.

---

**Note:** If you are sending the report to more than one email address, separate the addresses with a comma. The total cannot exceed 256 characters.

---

#### ◆ SNMP Trap Receivers

**SNMP Trap Receiver**

Enable SNMP Trap
  SNMPv3
 SNMPv2c
 SNMPv1

Receiver IP 1:

Service Port 1:

Community 1:

User name 1:

Auth-password 1:

Priv-Password 1:

Receiver IP 2:

Service Port 2:

Community 2:

User name 2:

Auth-password 2:

Priv-Password 2:

Up to four SNMP management stations can be specified. If you want to use SNMP trap notifications, do the following:

1. Check *Enable SNMP Trap*.
2. Select which version of SNMP you want to use.

3. Key in the IP address(es) and the service port number(s) of the computer(s) to be notified of SNMP trap events. The valid port range is 1–65535. The default port number is 162.

---

**Note:** Make sure that the port number you specify here matches the port number used by the SNMP receiver computer.

---

4. Key in the community value(s) if required for the SNMP version.
  5. Key in the auth/privacy password(s) that correspond to each of the stations.
- ◆ **Syslog Server**

**Syslog Server**

Enable Syslog Server

Server IP:

Service Port:

To record all the events that take place on eco PDU devices and write them to the IP Control Box’s Syslog server, do the following:

1. Check **Enable Syslog Server**.
2. Key in the IP address and the port number of the Syslog server. The valid port range is 1-65535. The default port number is 514.

## Date/Time

The Date/Time dialog page sets the IP Control Box time parameters:

**Date Time**

**Time Zone**

(UTC-12:00) Eniwetok Kwajalein ▼

Daylight Savings Time

**Manually Input**

Date:  (YYYY-MM-DD)

Time:  (HH:MM:SS)

Sync with PC

**Network Time**

Enable auto adjustment

AU | ntp1.cs.mu.OZ.AU ▼

Preferred custom server IP:

Alternate time server:

AU | ntp1.cs.mu.OZ.AU ▼

Alternate custom server IP:

Sync time every:   ▼

[Adjust Time Now](#)

- ◆ **Time Zone**
  - ◆ To establish the time zone that the IP Control Box is located in, drop down the *Time Zone* list and choose the city that most closely corresponds to where it is at.
  - ◆ If your country or region employs Daylight Saving Time (Summer Time), check the corresponding checkbox.
- ◆ **Manual Input**

Use this section to specify the IP Control Box's date and time manually.

- ◆ Click the calendar icon and click the calendar entry for the date.
- ◆ Key the time into the Time field, using the HH:MM:SS (hours, minutes, seconds) format.

---

**Note:** This section is only enabled when *auto adjustment* (in the *Network Time* section) is disabled (the checkbox is unchecked).

---

As an alternative to specifying the date and time by entering them into the date and time fields, you can click to put a check in the *Sync with PC* checkbox, in which case the eco PDU will take its date and time settings from the locally connected PC.

- ◆ **Network Time**

To have the time automatically synchronized to a network time server, do the following:

1. Check the *Enable auto adjustment* checkbox.
2. Drop down the time server list to select your preferred time server  
– or –

Check the *Preferred custom server IP* checkbox, and key in the IP address of the time server of your choice.

3. If you want to configure an alternate time server, check the *Alternate time server* checkbox, and repeat step 2 for the alternate time server entries.
4. Key in your choice for the number of days between synchronization procedures.

## **Finishing Up**

When you have finished making your settings on this page, click **Save**.

After you have saved your changes, if you want to synchronize immediately, click **Adjust Time Now**.

## Security

The *Security* page controls access to the IP Control Box device.



The screenshot shows a web interface titled "Security". Under the heading "Login Failures", there are two input fields. The first is labeled "Allowed:" and contains the number "3". The second is labeled "Timeout:" and contains the number "5", followed by the text "min".

### Login Failures

- ◆ Allowed:  
Enter the number of the allowed failed login attempts.
- ◆ Timeout:  
Enter the period that the account is locked out after the allowed failed login attempts.

### Working Mode

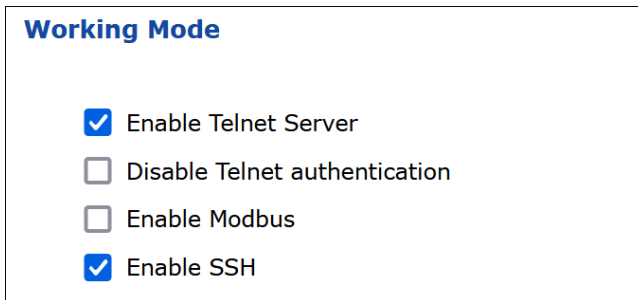

The screenshot shows a web interface titled "Working Mode" with four checkboxes and their corresponding labels:

- Enable Telnet Server
- Disable Telnet authentication
- Enable Modbus
- Enable SSH

- ◆ If *Enable Telnet Server* is checked, the PDU is accessible via a Telnet sessions using the Telnet username and password (see *Telnet*, page 32)
- ◆ If *Enable Modbus* is checked, the PDU is accessible and the measurements of the PDU such as current, voltage, power, temperature, humidity, and pressure can be read via the Modbus communications protocol.

- ◆ If *Enable SSH* is checked, the PDU is accessible and the measurements of the PDU such as current, voltage, power, temperature, humidity, and pressure can be read via the SSH cryptographic network protocol.

## TLS Support

**TLS Support**

Enable TLS1.0/TLS1.1

- ◆ If *TLS Support* is checked, the PDU is accessible on older computers or older web browsers that support TLS1.0 or TLS1.1 data encryption.

## IP Installer Setting

**IP Installer Setting**

Disable  Read-only  Read-write

- ◆ If *Disable* is checked, the IP address of the IP Control Box cannot be found by the IP Installer software.
- ◆ If *Readonly* is checked, the IP address of the IP Control Box can be found but not configurable by the IP Installer software.
- ◆ If *Read-write* is checked, the IP address of the IP Control Box can be found and configurable by the IP Installer software.

## Session Timeout

**Session Timeout**

Enable Web Session Timeout in  Minute(s)



- ◆ If *Enable Web Session Timeout in* is checked, a user's web session will logout due to inactivity after the number of *Minute(s)* entered (1–5) is surpassed.

## Account Policy

The Account Policy section governs policies in regard to usernames and passwords.

**Account Policy**

Minimum Username Length:

Minimum Password Length:

Password Must Contain at Least:
  One Upper Case  
 One Lower Case  
 One Number

Disable Duplicate Login

Check a policy and enter the required information in the appropriate fields.

Item	Description
Minimum Username Length	Sets the minimum number of characters required for a username. Acceptable values are from 1 to 16.
Minimum Password Length	Sets the minimum number of characters required for a password. Acceptable values are from 1 to 16.
Password Must Contain At Least	Checking any of these items requires users to include at least one of the specified items in their password. <b>Note:</b> This policy does not affect existing user accounts. Only new user accounts created after this policy has been enabled, and users required to change their passwords are affected.
Disable Duplicate Login	Check this to prevent users from logging in with the same account at the same time.

## IP Filter / Mac Filter

If any filters have been configured, they appear in the IP Filter and/or MAC Filter list boxes.

IP and MAC Filters control access to the eco PDU based on the IP and/or MAC addresses of the client computers attempting to connect. A maximum of 5 IP filters and 5 MAC filters are allowed.

To enable IP and/or MAC filtering, click to put a check mark in the *IP Filter Enable* and/or *MAC Filter Enable* checkbox.

- ◆ If the include button is checked, all the addresses within the filter range are allowed access; all other addresses are denied access.
- ◆ If the exclude button is checked, all the addresses within the filter range are denied access; all other addresses are allowed access.

The screenshot shows a configuration window titled "IP Filter/MAC Filter". It contains two sections. The first section is for IP filtering, with a checkbox for "IP Filter Enable" (unchecked), a radio button for "Include" (selected), and a radio button for "Exclude" (unchecked). Below this is a large empty text box for entering IP addresses, with "Add", "Modify", and "Delete" buttons to its right. The second section is for MAC filtering, with a checkbox for "MAC Filter Enable" (unchecked), a radio button for "Include" (selected), and a radio button for "Exclude" (unchecked). Below this is another large empty text box for entering MAC addresses, with "Add", "Modify", and "Delete" buttons to its right.

#### ◆ Adding Filters

To add an IP filter, do the following:

1. Click **Add**. A dialog box similar to the one below appears:

The dialog box has a title bar and contains the following text and fields: "Enter the start IP address (for example, 192.168.0.1):" followed by a text input field with a blue border. Below that is "Enter the end IP address (for example, 192.168.1.255):" followed by another text input field. At the bottom are "OK" and "Cancel" buttons.

2. Specify the start filter address in the dialog box (for example, 192.168.0.200), then click **OK**.
  3. To filter a single IP address, key in the same address as the start IP. To filter a continuous range of addresses, key in the end number of the range (for example, 192.168.0.225).
  4. After filling in the address, click **OK**.
- Repeat these steps for any additional IP addresses you want to filter.

To add a MAC filter, do the following:

1. Click **Add**. A dialog box similar to the one below appears:

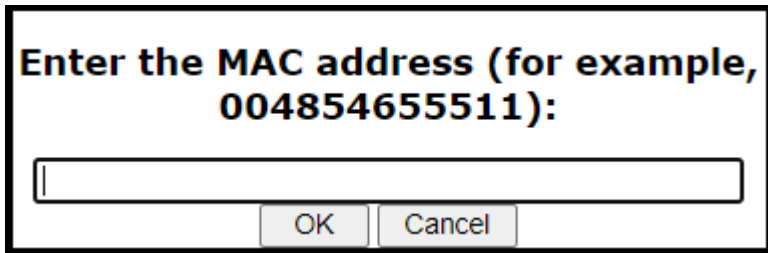

2. Specify the MAC address in the dialog box (for example, 001074670000), then click **OK**.

Repeat these steps for any additional MAC addresses you want to filter.

#### ◆ **IP Filter / MAC Filter Conflict**

If there is a conflict between an IP filter and a MAC filter—for example, where a computer's IP address is allowed by the IP filter but its MAC address is excluded by the MAC filter—then that computer's access is blocked.

In other words, if either filter blocks a computer, then the computer is blocked, no matter what the other filter is set to.

#### ◆ **Modifying Filters**

To modify a filter, select it in the IP Filter or MAC Filter list box and click **Modify**. The Modify dialog box is similar to the Add dialog box. When it comes up, simply delete the old address(es) and replace it with the new one(s).

#### ◆ **Deleting Filters**

To delete a filter, select it in the IP Filter or MAC Filter list box and click **Delete**.

## Authentication & Authorization

The Authentication & Authorization page is used to set up login authentication and authorization management from external sources.

**Authentication & Authorization**

Auth Type:

**RADIUS Settings**

Preferred RADIUS Server IP:

Preferred RADIUS Service Port:

Alternate RADIUS Server IP:

Alternate RADIUS Server Port:

Timeout:  sec

Retries:

Shared Secret (at least 6 characters):

### ◆ RADIUS Settings

To allow authentication and authorization for the eco PDU device through a RADIUS server, do the following:

1. Check **Enable**.
2. Fill in the IP addresses and service port numbers for the Preferred and Alternate RADIUS servers. The default port number for the Preferred server is 1812; the default port number for the Alternate server is 1645.

---

**Note:** Make sure that the port numbers you specify here match the port numbers used by the RADIUS servers.

---

3. In the *Timeout* field, set the time in seconds that the eco PDU device waits for a RADIUS server reply before it times out.
4. In the *Retries* field, set the number of allowed retries for attempting to connect to the RADIUS server.
5. In the *Shared Secret* field, key in the character string that you want to use for authentication between the eco PDU device and the RADIUS Server.
6. On the RADIUS server, set the entry for each user as follows:

```
su/administrator or su/user
```

Where *administrator / user* represents the username given to the user when the account was created on the eco PDU device. The user's access rights are the ones assigned for the eco PDU device, as well. (See *User Information*, page 32.)

---

**Note:** su/user supports view ports only; su/administrator supports all eco PDU functions.

---

## Private Certificate

When logging in over a secure (SSL) connection, a signed certificate is used to verify that the user is logging in to the intended site. For enhanced security, the *Private Certificate* section allows you to use your own private encryption key and signed certificate, rather than the default ATEN certificate.

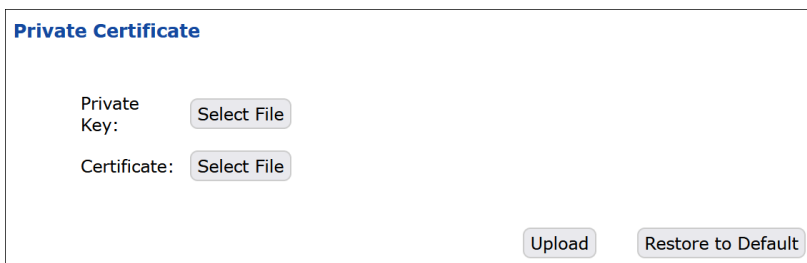

The screenshot shows a web interface titled "Private Certificate". It contains two rows of labels and buttons: "Private Key:" with a "Select File" button, and "Certificate:" with a "Select File" button. At the bottom right, there are two buttons: "Upload" and "Restore to Default".

There are two methods for establishing your private certificate: generating a self-signed certificate; and importing a third-party certificate authority (CA) signed certificate.

- ◆ **Generating a Self-Signed Certificate**

If you wish to create your own self-signed certificate, a free utility—`openssl.exe`—is available for download over the web.

- ◆ **Obtaining a CA Signed SSL Server Certificate**

For the greatest security, we recommend using a third party certificate authority (CA) signed certificate. To obtain a third party signed certificate, go to a CA (Certificate Authority) website to apply for an SSL certificate. After the CA sends you the certificate and private encryption key, save them to a convenient location on your computer.

- ◆ **Importing the Private Certificate**

To import the private certificate, do the following:

1. Click **Browse** to the right of *Private Key*; browse to where your private encryption key file is located; and select it.
2. Click **Browse** to the right of *Certificate*; browse to where your certificate file is located; and select it.
3. Click **Upload** to complete the procedure.

- 
- Note:**
1. Clicking **Restore Default** returns the device to using the default ATEN certificate.
  2. Both the private encryption key and the signed certificate must be imported at the same time.
- 

When you have finished making your settings on this page, click **Save**.

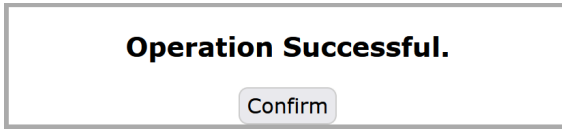

## **EcoTCP**

The *EcoTCP* page enables the communication between ecoDC software and the IP Control Box. To enable the EcoTCP, check the Enable service checkbox and specify the EcoDC IP and the EcoDC Port number.

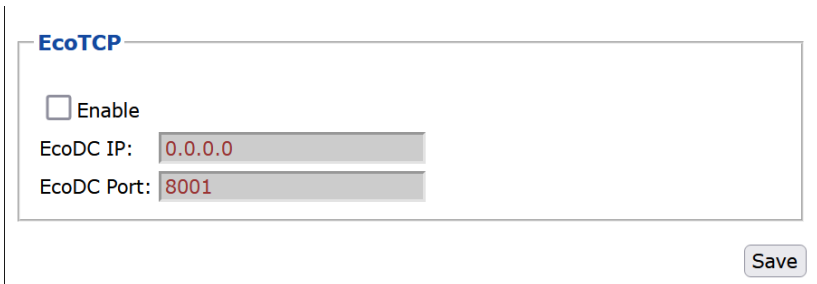

The EcoTCP configuration form is enclosed in a light gray border. At the top left, the title "EcoTCP" is displayed in blue. Below the title, there is a checkbox labeled "Enable". Underneath, there are two input fields: "EcoDC IP:" with the value "0.0.0.0" and "EcoDC Port:" with the value "8001". In the bottom right corner of the form, there is a rounded rectangular button labeled "Save".

## Scheduler

Use the *Scheduler* page to power on, power off, or reboot the IP Control Box.

[Scheduler](#)

**Events** + Create Event

Event Name	Frequency	08:00	Sun	Actions	
Reboot	Weekly	08:00	Sun	Power Reboot	<input checked="" type="checkbox"/>

**Actions** + Create Action

Action Name	Operation Time	Action	
Power Reboot	Immediately	Power ON	outlet 01,02,03,04
Power On	Use Delay Time	Power ON	outlet 01,02,03,04
Power Off	Immediately	Power OFF	outlet 01,02,03,04

To create an event, follow the steps below.

1. Go to **Setup > Scheduler**.
2. Create one or more power-on, power-off, and/or reboot actions. These actions will be selectable when configuring an event.
  - a) Click **+Create Action**.
  - b) In the pop-up screen, name the action, and use the drop-down lists to configure the action and the target outlet(s).

**← Create Action**

**Action Name**

**Action**  

---

**outlets**

[01]

[02]-

[03]

[04]

c) Click **Save**. The action is added to the list.

Action Name	Operation Time	Action
Power Reboot	Immediately	Power ON outlet 01,02,03,04

3. Create an event.

a) Click **+Create Event**.

b) In the pop-up screen, name the event, and then configure the schedule and action as needed.

**← Create Event**

**Event Name**

**Scheduled Time**    :

**Date**  Sun  Mon  Tue  Wed  Thu  Fri  Sat

---

**Actions**

Action Name	Operation Time	Action
Power Reboot	Immediately	Power Reboot outlet 01,02,03,04

c) Click **Save**. The event is added to the event list. Use the toggle button to enable/disable created events.

**Scheduler**

**Events** + Create Event

Event Name	Frequency	Time	Day	Actions	Toggle
Reboot	Weekly	08:00	Sun	Power Reboot	<input checked="" type="checkbox"/>

**Actions** + Create Action

Action Name	Operation Time	Action
Power Reboot	Immediately	Power Reboot outlet 01,02,03,04



## Mail Control

*Mail Control* is to send the CLI commands by email to control the IP Control Box. The default setting is disabled.

**Mail Control**

Enable

Control Username:

Control Password:

Approved Sender List:

Item	Description
Enable	Check the checkbox to enable mail control function.
Control Username	Define the username to perform mail control function. This field is required.
Control Password	Set the password of <b>Control Username</b> . This field is required.
Approved Sender List	Enter the email address(es) that is allowed to send commands through email to control the IP Control Box. To add multiple senders, use a comma to separate email addresses. Please note that a space character is not accepted in the entry. Do not enter space characters between email address and comma.

## Mail Client

**Mail Client:**

Mail Address:

Username:

Password:

*Mail Client* is to set the email address that receives the commands from the approved sender(s) and sends the notification emails to the recipients on *Approved Sender List*.

Item	Description
Mail Address	Enter the address of the email account that you'd like to use to send the notification emails and receive the email(s) whose content contains commands to control the IP Control Box.
Username / Password	Enter the login credentials in your email client.

## Receive Mail Server

Fill in the following information to define your mail server of the email account that you set to receive the command email(s).

Receive Mail Server	
Server Address:	<input type="text"/>
Server Port:	<input type="text" value="995"/>
<input checked="" type="radio"/> IMAP	<input checked="" type="checkbox"/> IMAPS
<input type="radio"/> POP3	<input checked="" type="checkbox"/> POP3S
Checking Interval (sec):	<input type="text" value="10"/>

Item	Description
Server Address	Enter server address of the email provider that you use to retrieve the command email(s) from the mail server.
Server Port	Enter the port number that your email server uses.
IMAP / POP3	Click the radio button to select the protocol (methods) used for accessing emails. The options are <b>IMAP</b> and <b>POP3</b> . To encrypt and secure the incoming mails, enable the checkbox of <b>IMAPS / POP3S</b> after selecting <b>IMAP</b> or <b>POP3</b> as the protocol.
Checking Interval (sec)	Set the time you'd like to check for new incoming mails automatically.

## Send Mail Server

Specify the information about your outgoing email server.

Send Mail Server	
Server Address:	<input type="text"/>
Server Port:	<input type="text" value="465"/>
<input checked="" type="checkbox"/> SMTPS	

Item	Description
Server Address	Enter the outgoing email server address of your email provider.
Server Port	Enter the port number that your email server uses.
SMTPS	Enable the checkbox to encrypt and secure the outgoing emails.

## Commands Sent by Email

Once the *Mail Control* configurations are done, you are able to control the IP Control Box through email(s) sent from the email address(es) on *Approved Sender List*.

The command script must be one command per line, starts with the control username and control password, and end with the command “end”.

The following is an example of email content for mail control:

```
mailadmin
mailpwd
sw o01 on
sw o02 on
sw o03 on
sw o04 on
end
```

In this example, “mailadmin” stands for the control username while “mailpwd” is the control password. Please input your control username and control password in your command script. “End” in the last line indicates that the command script ends. For more commands that controls the IP Control Box, see *Commands*, page 66.

## PDU

The *PDU* tab is used to upgrade the PE4104A / PE4104AJ / PE4104G's firmware, and to backup and restore the device's configuration settings.

### Upgrade Main Firmware

The *Upgrade Main Firmware* page is used to upgrade the firmware of the IP Control Box.

#### Firmware File

When you click the **Upgrade Main Firmware** tab, the display opens with the *Firmware file* menu page, which looks similar to the one below:

**Firmware File**

Check Main Firmware Version

Energy Box Name	Firmware Version
PE4104AJ	[PE4104AJ] Firmware Version: 1.2.118

Filename:

A description of the items shown in this panel are given in the table, below:

Item	Description
Check Main Firmware Version	If you enable <i>Check Main Firmware Version</i> , the eco PDU's current firmware level is compared with that of the upgrade file. If the current version is equal to or higher than the upgrade version, a popup message appears, to inform you of the situation and stops the upgrade procedure.
Energy Box Name	Lists all of the eco PDU devices. Click to put a check in the checkbox of the device's whose firmware you want to upgrade.
Firmware Version	Displays the eco PDU's current firmware version.
Filename	As new versions of the firmware become available, they are posted on our website and can be downloaded to a convenient location on your computer. Click the <i>Select File</i> button to select the downloaded upgrade file.
Upgrade	Click this button to upgrade the firmware of the selected devices.

#### ◆ Upgrading the Firmware

To upgrade the firmware refer to the screenshot on the preceding page, and do the following:

1. Go to our website and download the new firmware file to a convenient location on your computer.
  2. Click the *Select File* button; navigate to where the firmware file is located and select it.
  3. Click **Upgrade** to start the upgrade procedure.
    - ◆ If you enabled *Check Main Firmware Version* the current firmware level is compared with that of the upgrade file. If the current version is equal to or higher than the upgrade version, a popup message appears, to inform you of the situation and stops the upgrade procedure.
    - ◆ If you didn't enable *Check Main Firmware Version*, the upgrade file is installed without checking what its level is.
    - ◆ Once the upgrade completes successfully, the switch resets itself.
  4. Log in again, and check the firmware version to be sure it is the new one.
- 
- ◆ **Firmware Upgrade Recovery**

Should the eco PDU's firmware upgrade procedure fail, and the device becomes unusable, the following firmware upgrade recovery procedure will resolve the problem:

1. Power off the device.
2. Press and hold the Reset Switch in (see page 6).
3. While holding the Reset Switch in, power the switch back on.

This causes the switch to use the original factory installed main firmware version. Once the switch is operational, you can try upgrading the main firmware again.

## Backup/Restore

Selecting *Backup/Restore* on the menu bar gives you the ability to back up the switch's configuration and user profile information.

## Station List

Station List lists the IP Control Box only.

Station List		
Energy Box Name		Filename
PE4104AJ	[PE4104AJ]	Please select a file to restore ▾

## Backup

Backup
Password: <input type="password" value="••••••"/>
<input type="button" value="Save"/>

To backup the device's settings do the following:

1. In the *Password* field, key in a password for the file.

---

**Note:** Entering a password is optional. If you do enter a password, make a note of it, since you will need it to be able to restore the file.

---

2. Click **Save**.
3. When the browser asks what you want to do with the file, select *Save to disk*; then save it in a convenient location.

## Restore

**Restore**

Auto Mapping

Password:

Filename:

To restore a previous backup, do the following:

1. Click **Browse**; navigate to the file and select it.

---

**Note:** If you renamed the file, you can leave the new name. There is no need to return it to its original name.

---

2. In the *Password* field, key in the same password that you used to save the file.

---

**Note:** If you did not set a password when you created the backup file, you can omit this step.

---

3. Select as many of the options that are presented as you wish to restore.
4. Click **Restore**.

After the file is restored, a message appears to inform you that the procedure succeeded.

This Page Intentionally Left Blank



# Chapter 5

## Telnet Commands

### Remote Terminal Operations

---

With ATEN IP Control Box you can log in remotely from a computer using Telnet interface that allows system control through a high-end controller or PC.

#### Telnet

Telnet is a program that connects to a device over a network to provide text-based management and control. Telnet provides some of the same management features found in the IP Control Box's web GUI. You can reference the IP Control Box's web GUI functions by downloading the user manual from our website ([www.aten.com](http://www.aten.com)). This can help you as you work your way through the text-based commands used to control the eco PDU that are discussed in this guide.

Telnet is available on all eco PDUs installed with the latest firmware. You can log in to the IP Control Box via Telnet from any computer connected to the same network.

#### Setup

Log in to the PE4104G's web GUI, go to the **Setup** tab and click **Security** from the menu bar. Under **Working Mode**, check *Enable Telnet Server* and then click **Save** at the bottom of the page.

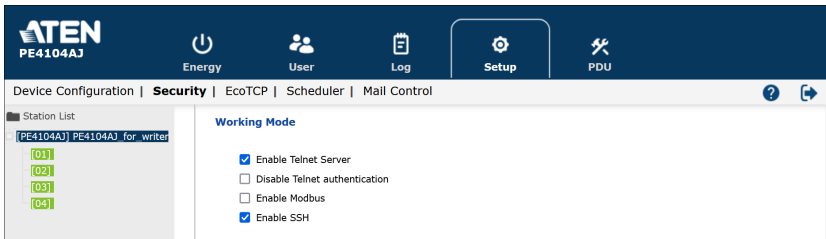

---

**Note:** If the *Enable Telnet Server* option is not available, please download the latest firmware from our website.

---

## Logging In

To log in to the IP Control Box via Telnet, do the following:

1. On your computer, open the start menu and select **Run**. Type: *cmd*

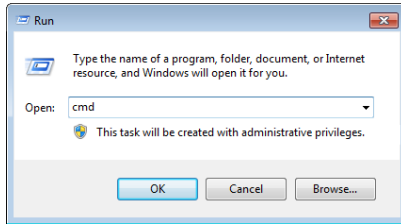

Click **OK**.

2. At the command prompt, key in *telnet* and the IP Address of the PDU, as follows:

```
telnet [IP Address]
```

3. Press **Enter**. The login screen appears:

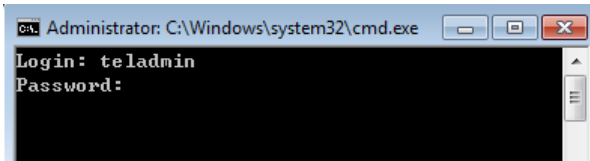

4. At the login prompt, enter the username: **teladmin**; and the password: **telpwd**.

---

**Note:** The Telnet username and password can be configured on the User tab of the IP Control Box's web GUI.

---

5. When the Telnet session is established, *Logged in successfully* appears along with the command line prompt:

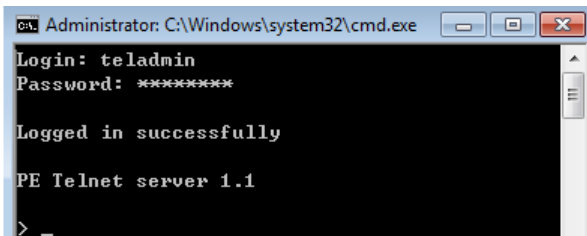

## **Session Timeout**

A live Telnet connection would be terminated if there is no incoming data with 60 Seconds.

## Commands

---

Use the Telnet commands to view and configure the IP Control Box as described in each section. The text-based command line provides some of the same functions found under the Energy tab of the IP Control Box's web-based GUI. Commands to view and configure the IP Control Box are provide in the following sections. You can reference information provided in the user manual for the functions as you use the commands.

### Verification

After sending an incorrect command, a verification message appears at the end of the command line.

- ◆ **Invalid command or exceed max command length** - the command has the wrong format and/or values. Try typing in the command string again using the correct format and/or values.

## Read Power Outlet Status

The Read Power Outlet Status command allows you to view the power status of an outlet on the IP Control Box.

The formula for Read Outlet Status commands is as follows:

**Command + Outlet + Number + Option + [Enter]**

1. For example, if you want to read the status of outlet 01 with a simple return string, type the following:

**read status o01 simple [Enter]**

2. For example, if you want to read the status of outlet 12 with a format return string, type the following:

**read status o12 format [Enter]**

The following tables show the possible values for the Read Outlet Status commands:

Command	Description
read status	Read status command

Outlet	Description
o	Outlet command
xx	PDU Outlet number xx: Outlet on PDU (01 ~ 04) Example: o02

Option	Description
simple	Return simple string of the selected power outlet status
format	Return format string of the selected power outlet status

The following table lists the available Read Outlet Status commands:

Command	Outlet	Option	Enter	Description
read status	oXX	simple	[Enter]	Read the status of outlet XX with a simple return string. XX: Outlet number (01 ~ 04)
read status	oXX	format	[Enter]	Read the status of outlet XX with a format return string. XX: Outlet number (01 ~ 04)

**Note:** 1. Each command string can be separated with a space.

2. The **Option** command string can be skipped and **format** will be used by default.

## **Switch Outlet Status**

The Switch Outlet Status command allows you to change the power status of an outlet on the IP Control Box.

The formula for Switch Outlet Status commands is as follows:

**Command + Outlet + Number + Option + Control + [Enter]**

1. For example, if you want to switch off outlet 04 immediately, type the following:

**sw o04 imme off [Enter]**

2. For example, if you want to switch on outlet 01 with the time delay set for the outlet, type the following:

**sw o01 delay on [Enter]**

3. For example, if you want to reboot outlet 03, type the following:

**sw o03 reboot [Enter]**

The following tables show the possible values for the Switch Outlet Status commands:

Command	Description
sw	Switch outlet status command
Outlet	Description
o	Outlet command
xx	PDU Outlet number xx: Outlet on PDU (01 ~ 04) Example: o02
Option	Description
imme	Switch outlet status immediately
delay	Switch outlet status with pre-configured delay time
Control	Description
on	Switch outlet on
off	Switch outlet off
reboot	Switch outlet off and then switch outlet on

The following table lists the available Switch Outlet Status commands:

Command	Outlet	Option	Control	Enter	Description
sw	oXX	imme delay	on	[Enter]	Switch outlet XX on with option imme or delay. XX: Outlet number (01 ~ 04)
sw	oXX	imme delay	off	[Enter]	Switch outlet XX off with option imme or delay. XX: Outlet number (01 ~ 04)
sw	oXX		reboot	[Enter]	Switch outlet XX off and on. XX: Outlet number (01 ~ 04)

**Note:** 1. Each command string can be separated with a space.

2. The **Option** command string can be skipped and **delay** will be used by default.

## **Read Environmental Value**

The Read Environmental Value command allows you to view measurements from the IP Control Box's environmental sensors.

The formula for Read Environmental Value commands is as follows:

**Command + Outlet + Number + Option + [Enter]**

1. For example, if you want to read environmental sensor 02 with a simple return string, type the following:

**read sensor o02 simple [Enter]**

2. For example, if you want to read environmental sensor 01 with a format return string, type the following:

**read sensor o01 format [Enter]**

The following tables show the possible values for the Read Environmental Value commands:

<b>Command</b>	<b>Description</b>
read sensor	Read environmental sensor value command.

<b>Outlet</b>	<b>Description</b>
o	Outlet with environmental sensor installed command
xx	PDU Outlet number with environmental sensor installed xx: Outlet on PDU (01 ~ 04) Example: o02

<b>Option</b>	<b>Description</b>
simple	Return simple string of the environmental sensor value on the selected power outlet with environmental sensor installed.
format	Return format string of the environmental sensor value on the selected power outlet with environmental sensor installed.



The following table lists the available Read Environmental Value commands:

Command	Sensor	Option	Enter	Description
read sensor	oXX	simple format	[Enter]	Read the environmental sensor value on the selected power outlet with environmental sensor installed. Outlet XX with option simple or format. XX: Outlet number (01 ~ 04).

**Note:** 1. Each command string can be separated with a space.

2. The **Option** command string can be skipped and **format** will be used by default.

## Close Telnet Session

The Close Telnet Session command allows you to disconnect the telnet session from the IP Control Box.

The formula for the Close Telnet Session command is as follows:

**Command + [Enter]**

1. For example, if you want to disconnect the telnet session, type the following:

**quit [Enter]**

The following table shows the value for the Close Telnet Session command:

Command	Description
quit	Close telnet session command

The following table lists the Close Telnet Session command:

Command	Enter	Description
quit	[Enter]	Disconnects telnet session with PE4104G.

## **Reboot PDU Device**

The Reboot PDU Device command allows you to reboot the IP Control Box.

The formula for Reboot PDU Device commands is as follows:

**Command + [Enter]**

1. For example, if you want to reboot the IP Control Box, type the following:

**reboot [Enter]**

The following tables show the possible values for the Read Environmental Value commands:

Command	Description
reboot	Reboot PDU device command

The following table lists the available Reboot PDU Device command:

Command	Enter	Description
reboot	[Enter]	Reboots the IP Control Box.

## **Reset All PDU Config to Default Value**

The Reset All PDU Config to Default command allows you to reset the IP Control Box to the default factory settings.

The formula for Reset All PDU Config to Default Value commands is as follows:

**Command + [Enter]**

1. For example, if you want to reset the IP Control Box, type the following:

**clearallsetting [Enter]**

The following tables show the possible values for the Reset All PDU Config to Default Value commands:

Command	Description
clearallsetting	Reset all PDU configuration to default value command

The following table lists the available Reset All PDU Config to Default Value command:

<b>Command</b>	<b>Enter</b>	<b>Description</b>
clearallsetting	[Enter]	Resets the IP Control Box to default factory settings.

This Page Intentionally Left Blank

## Safety Instructions

---

### General

- ◆ This product is for indoor use only.
- ◆ Read all of these instructions. Save them for future reference.
- ◆ Follow all warnings and instructions marked on the device.
- ◆ Do not place the device on any unstable surface (cart, stand, table, etc.). If the device falls, serious damage will result.
- ◆ Do not use the device near water.
- ◆ Do not place the device near, or over, radiators or heat registers.
- ◆ The device cabinet is provided with slots and openings to allow for adequate ventilation. To ensure reliable operation, and to protect against overheating, these openings must never be blocked or covered.
- ◆ The device should never be placed on a soft surface (bed, sofa, rug, etc.) as this will block its ventilation openings. Likewise, the device should not be placed in a built in enclosure unless adequate ventilation has been provided.
- ◆ Never spill liquid of any kind on the device.
- ◆ Unplug the device from the wall outlet before cleaning. Do not use liquid or aerosol cleaners. Use a damp cloth for cleaning.
- ◆ The device should be operated from the type of power source indicated on the marking label. If you are not sure of the type of power available, consult your dealer or local power company.
- ◆ The device is designed for IT power distribution systems with 100V to 230V phase-to-phase voltage.
- ◆ To prevent damage to your installation it is important that all devices are properly grounded.
- ◆ Do not allow anything to rest on the power cord or cables. Route the power cord and cables so that they cannot be stepped on or tripped over.
- ◆ The device is equipped with a 3-wire grounding type plug. This is a safety feature. If you are unable to insert the plug into the outlet, contact your electrician to replace your obsolete outlet. Do not attempt to defeat the purpose of the grounding-type plug. Always follow your local/national wiring codes.

- ◆ If an extension cord is used with this device make sure that the total of the ampere ratings of all products used on this cord does not exceed the extension cord ampere rating. Make sure that the total of all products plugged into the wall outlet does not exceed 15 amperes.
- ◆ To help protect your system from sudden, transient increases and decreases in electrical power, use a surge suppressor, line conditioner, or uninterruptible power supply (UPS).
- ◆ Position system cables and power cables carefully; Be sure that nothing rests on any cables.
- ◆ Never push objects of any kind into or through cabinet slots. They may touch dangerous voltage points or short out parts resulting in a risk of fire or electrical shock.
- ◆ Do not attempt to service the device yourself. Refer all servicing to qualified service personnel.
- ◆ If the following conditions occur, unplug the device from the wall outlet and bring it to qualified service personnel for repair.
  - ◆ The power cord or plug has become damaged or frayed.
  - ◆ Liquid has been spilled into the device.
  - ◆ The device has been exposed to rain or water.
  - ◆ The device has been dropped, or the cabinet has been damaged.
  - ◆ The device exhibits a distinct change in performance, indicating a need for service.
  - ◆ The device does not operate normally when the operating instructions are followed.
- ◆ Only adjust those controls that are covered in the operating instructions. Improper adjustment of other controls may result in damage that will require extensive work by a qualified technician to repair.
- ◆ Do not connect the RJ-11 connector marked “UPGRADE” to a public telecommunication network.

## **Rack Mounting**

- ◆ Before working on the rack, make sure that the stabilizers are secured to the rack, extended to the floor, and that the full weight of the rack rests on the floor. Install front and side stabilizers on a single rack or front stabilizers for joined multiple racks before working on the rack.
- ◆ Always load the rack from the bottom up, and load the heaviest item in the rack first.
- ◆ Make sure that the rack is level and stable before extending a device from the rack.
- ◆ Do not overload the AC supply branch circuit that provides power to the rack. The total rack load should not exceed 80 percent of the branch circuit rating.
- ◆ Make sure that all equipment used on the rack—including power strips and other electrical connectors—is properly grounded.
- ◆ Ensure that proper airflow is provided to devices in the rack.
- ◆ Ensure that the operating ambient temperature of the rack environment does not exceed the maximum ambient temperature specified for the equipment by the manufacturer.
- ◆ Do not step on or stand on any device when servicing other devices in a rack.

## Administrator Login Failure

If you are unable to perform an administrator login (because the username and password information has become corrupted, or you have forgotten it, for example), you can clear the login information with the following procedure:

1. Power off the IP Control Box and remove its housing.
2. Short the jumper labeled J5 (PIN1 and PIN2).

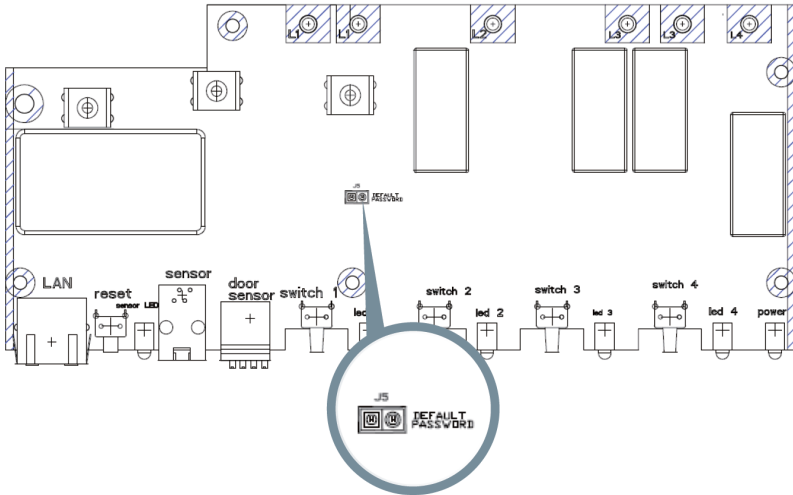

3. Close the housing and start the IP Control Box.  
After you start, you can log in by using the default username: *administrator*; and the default password: *password*.



## IP Address Determination

If you are an administrator logging in for the first time, you need to access the eco PDU in order to give it an IP address that users can connect to. There are two methods to choose from. In each case, your client computer must be on the same network segment as the eco PDU. After you have connected and logged in you can give the device its fixed network address. (See *Event Notification*, page 40.)

### Method 1:

For computers running Windows, an IP address can be determined and/or assigned with the IP Installer utility. The utility can be obtained from the *Download* area of our web site or from the software CD. Look under *Driver/SW*, and the model of your device. After downloading the utility to your computer, do the following:

1. Unzip the contents of *IPInstaller.zip* to a directory on your hard drive.
2. Go to the directory that you unzipped the IPInstaller program to and run *IPInstaller.exe*. A dialog box similar to the one below appears:

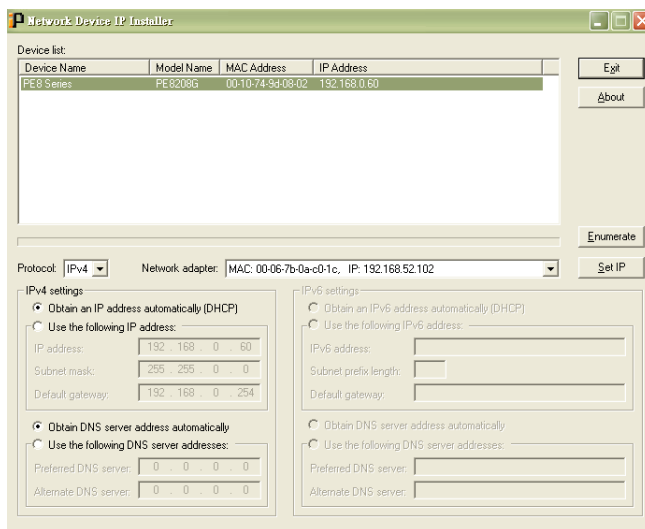

(Continues on next page.)

(Continued from previous page.)

3. Select the device in the *Device List*.

---

**Note:** 1. If the list is empty, or your device doesn't appear, click **Enumerate** to refresh the Device List.

2. If there is more than one device in the list, use the MAC address to pick the one you want. The eco PDU's MAC address is located on its bottom panel.
- 

4. Select either *Obtain an IP address automatically (DHCP)*, or *Specify an IP address*. If you chose the latter, fill the IP Address, Subnet Mask, and Gateway fields with the information appropriate to your network.
5. Click **Set IP**.
6. After the IP address shows up in the Device List, click **Exit** to end the program.

### **Method 2:**

1. Set your computer's IP address to 192.168.0.XXX  
Where XXX represents any number or numbers except 60. (192.168.0.60) is the default address of the eco PDU.)
2. Specify the device's default IP address (192.168.0.60) in your browser, and you will be able to connect.
3. Assign a fixed IP address for the device (see *IPv4 Configuration*, page 39), that is suitable for the network segment that it resides on.
4. After you log out, reset your computer's IP address to its original value.
5. Once you have logged in, go to Network Settings to set up the permanent IP environment (see *IPv4 Configuration*, page 39).

### **Method 3:**

eco DC allows you to determine/assign an IP address in order to configure a PDU device and monitor power status of the equipment connected to it. eco DC can be obtained from the Download area of the ATEN web site.

## Technical Support

---

### International

- ◆ For online technical support—including troubleshooting, documentation, and software updates: <http://support.aten.com>
- ◆ For telephone support, see *Telephone Support*, page iv

### North America

Email Support		<a href="mailto:support@aten-usa.com">support@aten-usa.com</a>
Online Technical Support	Troubleshooting Documentation Software Updates	<a href="http://www.aten-usa.com/support">http://www.aten-usa.com/support</a>
Telephone Support		1-888-999-ATEN ext 4988 1-949-428-1111

When you contact us, please have the following information ready beforehand:

- ◆ Product model number, serial number, and date of purchase.
- ◆ Your computer configuration, including operating system, revision level, expansion cards, and software.
- ◆ Any error messages displayed at the time the error occurred.
- ◆ The sequence of operations that led up to the error.
- ◆ Any other information you feel may be of help.

## Specifications

### PE4104A

<b>Outlet</b>		4 x NEMA 5 - 15P
<b>Inlet</b>		SR
<b>LAN Port</b>		1 x RJ-45 Female with LEDs (Silver / LED: Orange / Green) 10/100M
<b>LED</b>	<b>Outlet</b>	4 x Green
	<b>Power</b>	1 x Orange
	<b>Sensor</b>	1 x Orange
<b>Buttons</b>	<b>Reset</b>	1 x Semi-recessed Pushbutton
	<b>Select</b>	4 x Select Pushbuttons
<b>Sensor Port</b>		1 x RJ11
<b>Door Sensor</b>		1 x Phoenix Connector (+12/D+/D-/G)
<b>Electrical</b>		
Nominal Input Voltage		100–120 VAC
Maximum Input Current		15A (Max), 12A (UL de-rated)
Input Frequency		50–60Hz
Input Connection		NEMA 5-15P
Input Power		1800VA (Max), 1440VA (UL de-rated)
Outlet Type		(4) NEMA 5-15R
Normal Output Voltage		100–120 VAC
Maximum Output Current (Outlet)		15A (Max), 12A (UL de-rated)
Maximum Output Current (Bank)		15A (Max), 12A (UL de-rated)
Maximum Output Current (Total)		15A (Max), 12A (UL de-rated)
Circuit Breakers		Yes (UL1077)
Metering		No
Outlet Switching		Yes
<b>Power Consumption</b>		AC110V:3.1W AC220V:3.5W
<b>Physical Properties</b>		
Housing		Metal
Dimensions (W x L x H)		20.00 x 12.81 x 4.40 cm

---

Weight	0.9 kg
Power Cord Length	3 m
<b>Environmental</b>	
Temperature (Operating / Storage)	0–50°C / –20–60°C
Humidity (Operating / Storage)	0–80°C RH, Non-Condensing
<b>Compliance</b>	
EMC Verification	FCC Class A
Safety Verification	By request

---

**PE4104AJ**

<b>Outlet</b>		4 x NEMA 5 - 15P
<b>Inlet</b>		SR
<b>LAN Port</b>		1 x RJ-45 Female with LEDs (Silver / LED: Orange / Green) 10/100M
<b>LED</b>	<b>Outlet</b>	4 x Green
	<b>Power</b>	1 x Orange
	<b>Sensor</b>	1 x Orange
<b>Buttons</b>	<b>Reset</b>	1 x Semi-recessed Pushbutton
	<b>Select</b>	4 x Select Pushbuttons
<b>Sensor Port</b>		1 x RJ11
<b>Door Sensor</b>		1 x Phoenix Connector (+12/D+/D-/G)

**Electrical**

Nominal Input Voltage	100–120 VAC
Maximum Input Current	15A (Max)
Input Frequency	50–60Hz
Input Connection	NEMA 5 - 15P
Input Power	1800VA (Max)
Outlet Type	(4) NEMA 5 - 15R
Normal Output Voltage	100–120 VAC
Maximum Output Current (Outlet)	15A (Max)
Maximum Output Current (Bank)	15A (Max)
Maximum Output Current (Total)	15A (Max)
Circuit Breakers	Yes
Metering	No
Outlet Switching	Yes
<b>Power Consumption</b>	AC 110 V : 3.1 W

**Physical Properties**

Housing	Metal
Dimensions (W x L x H)	20.00 x 14.59 x 4.40 cm
Weight	1.15 kg
Power Cord Length	1.8 m

**Environmental**

---

Temperature (Operating / Storage)	0–50°C / –20–60°C
Humidity (Operating / Storage)	0–80°C RH, Non-Condensing
<b>Compliance</b>	
EMC Verification	FCC Class A
Safety Verification	PSE

---

**PE4104G**

<b>Outlet</b>		4 x IEC C13
<b>Inlet</b>		IEC C14
<b>LAN Port</b>		1 x RJ-45 Female with LEDs (Silver / LED: Orange / Green) 10/100M
<b>LED</b>	<b>Outlet</b>	4 x Green
	<b>Power</b>	1 x Orange
	<b>Sensor</b>	1 x Orange
<b>Buttons</b>	<b>Reset</b>	1 x Semi-recessed Pushbutton
	<b>Select</b>	4 x Select Pushbuttons
<b>Sensor Port</b>		1 x RJ11
<b>Door Sensor</b>		1 x Phoenix Connector (+12/D+/D-/G)
<b>Electrical</b>		
Nominal Input Voltage		100–240 VAC
Maximum Input Current		10A (Max)
Input Frequency		50–60Hz
Input Connection		IEC C14
Input Power		2400VA (Max)
Outlet Type		(4) IEC 320 C13
Normal Output Voltage		100–240 VAC
Maximum Output Current (Outlet)		10A (Max)
Maximum Output Current (Bank)		10A (Max)
Maximum Output Current (Total)		10A (Max)
Circuit Breakers		Yes (UL1077)
Metering		No
Outlet Switching		Yes
<b>Power Consumption</b>		AC110V:3.1W AC220V:3.5W
<b>Physical Properties</b>		
Housing		Metal
Dimensions (W x L x H)		20.00 x 12.81 x 4.40 cm
Weight		0.9 kg
Power Cord Length		3 m



---

**Environmental**

Temperature (Operating / Storage)	0–50°C / –20–60°C
-----------------------------------	-------------------

Humidity (Operating / Storage)	0–80°C RH, Non-Condensing
--------------------------------	---------------------------

**Compliance**

EMC Verification	CE-EMC
------------------	--------

Safety Verification	CE-LVD
---------------------	--------

---

## **ATEN Standard Warranty Policy**

---

### **Limited Hardware Warranty**

ATEN warrants its hardware in the country of purchase against flaws in materials and workmanship for a Warranty Period of two [2] years (warranty period may vary in certain regions/countries) commencing on the date of original purchase. This warranty period includes the **LCD panel of ATEN LCD KVM switches**. For UPS products, the device warranty is two [2] years but battery is one [1] year. Select products are warranted for an additional year (see *A+ Warranty* for further details). Cables and accessories are not covered by the Standard Warranty.

### **What is covered by the Limited Hardware Warranty**

ATEN will provide a repair service, without charge, during the Warranty Period. If a product is defective, ATEN will, at its discretion, have the option to (1) repair said product with new or repaired components, or (2) replace the entire product with an identical product or with a similar product which fulfills the same function as the defective product. Replaced products assume the warranty of the original product for the remaining period or a period of 90 days, whichever is longer. When the products or components are replaced, the replacing articles shall become customer property and the replaced articles shall become the property of ATEN.

To learn more about our warranty policies, please visit our website:  
<http://www.aten.com/global/en/legal/policies/warranty-policy/>

© Copyright 2023 ATEN® International Co., Ltd.  
Released: 2023-09-28

ATEN and the ATEN logo are registered trademarks of ATEN International Co., Ltd. All rights reserved. All other brand names and trademarks are the registered property of their respective owners.